

WINGS: MAKE TWO LEFTHAND AND TWO RIGHTHAND

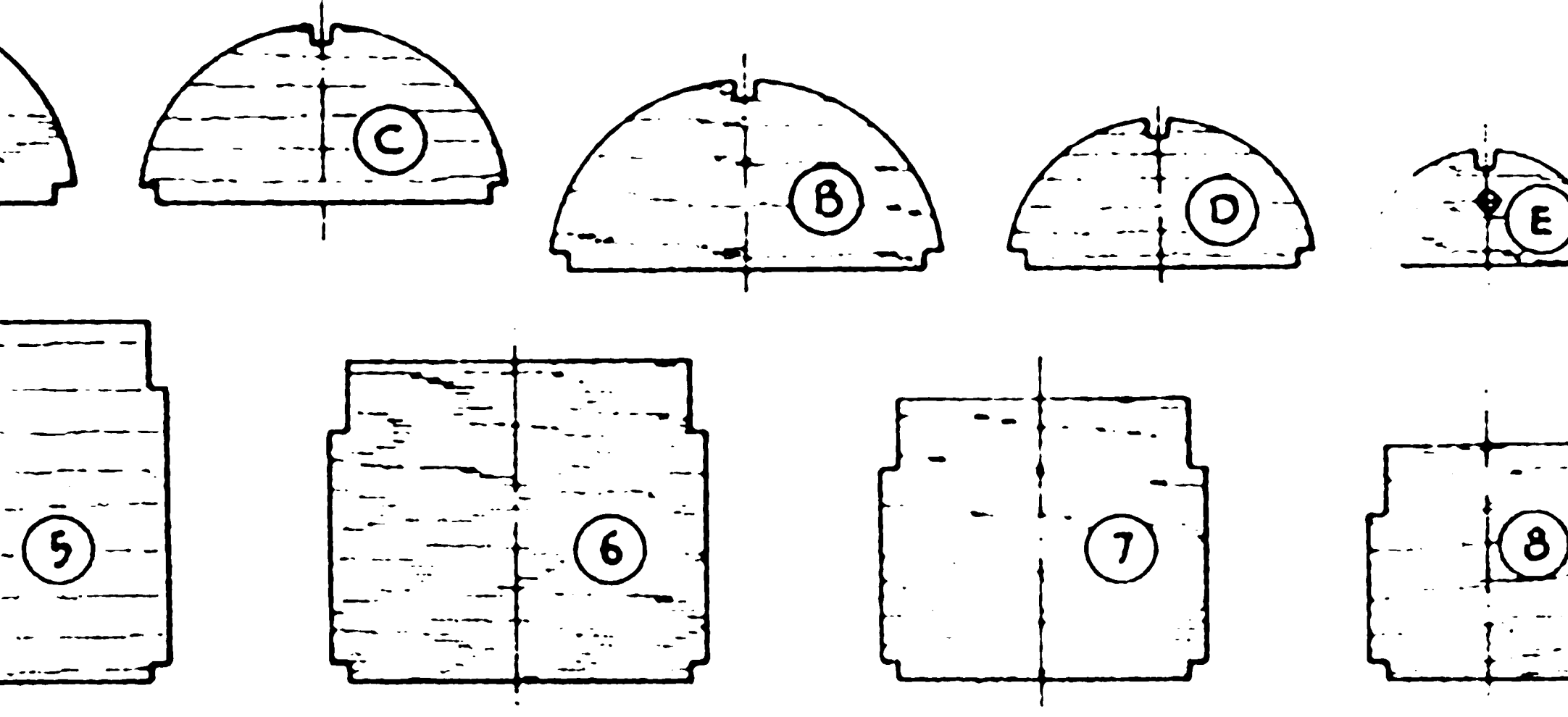
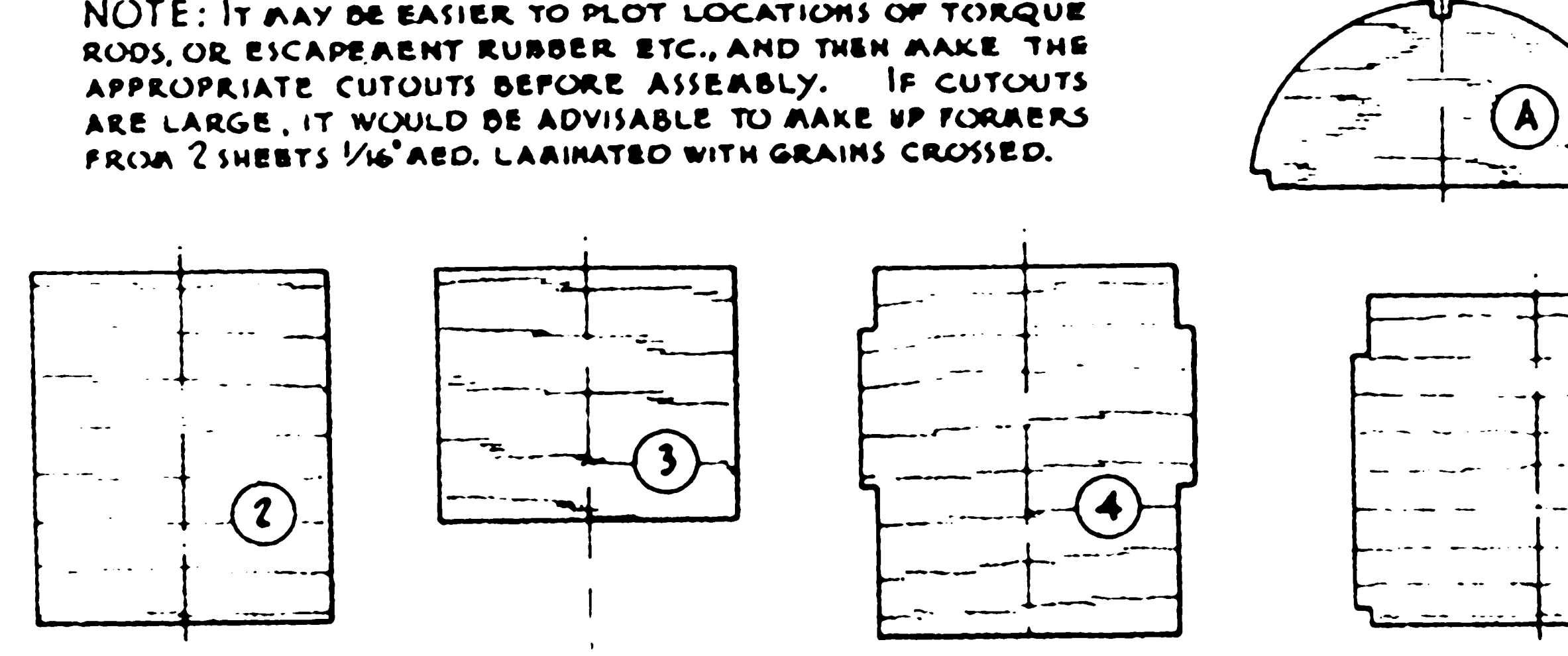
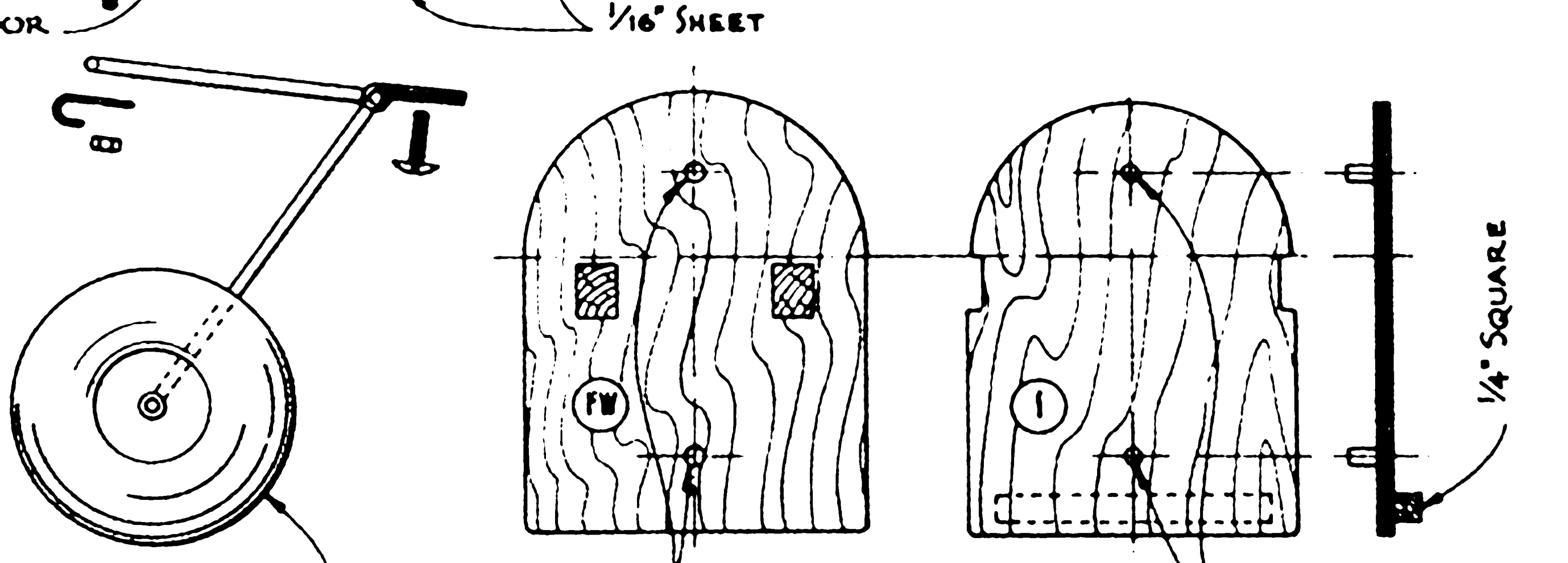
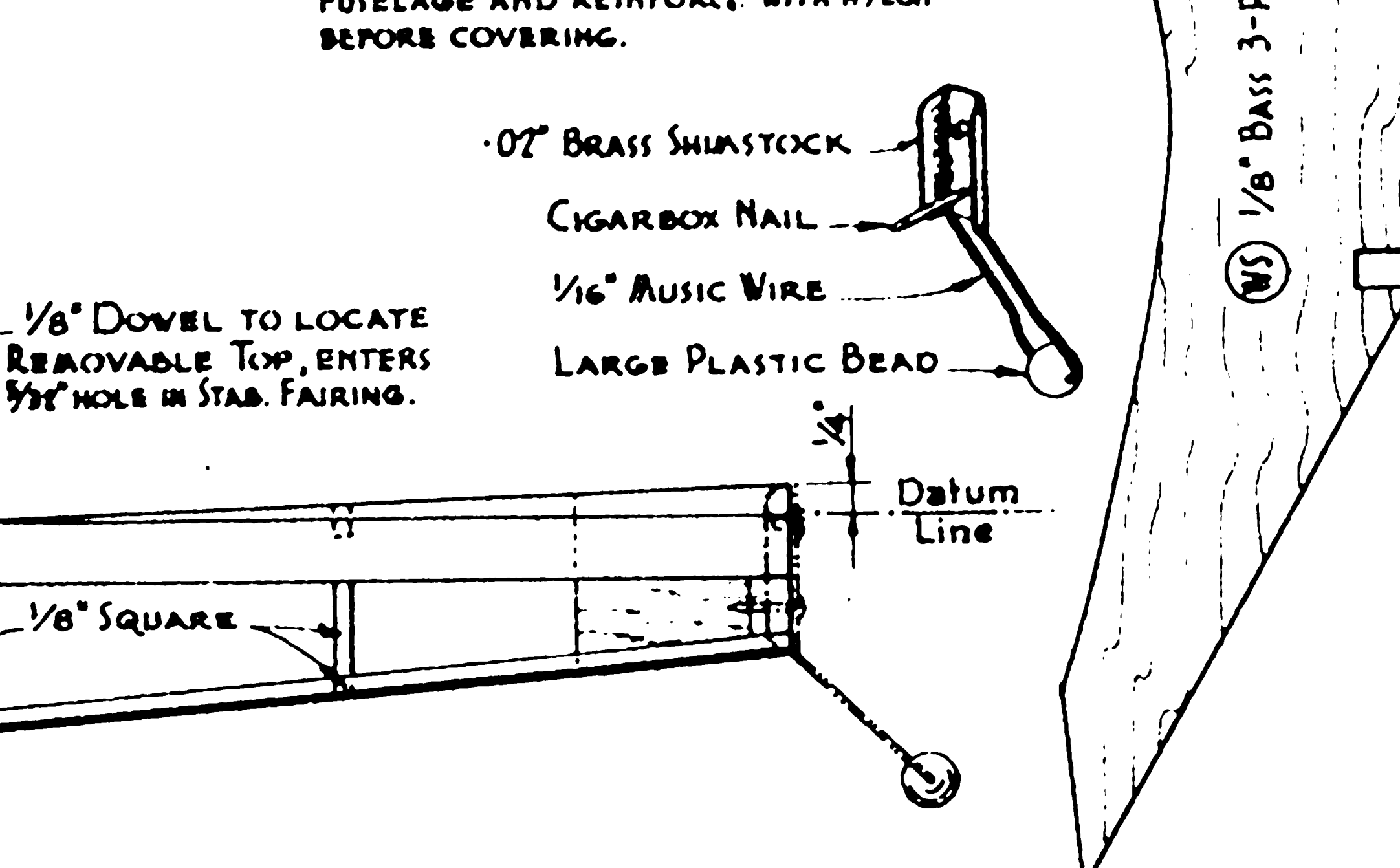
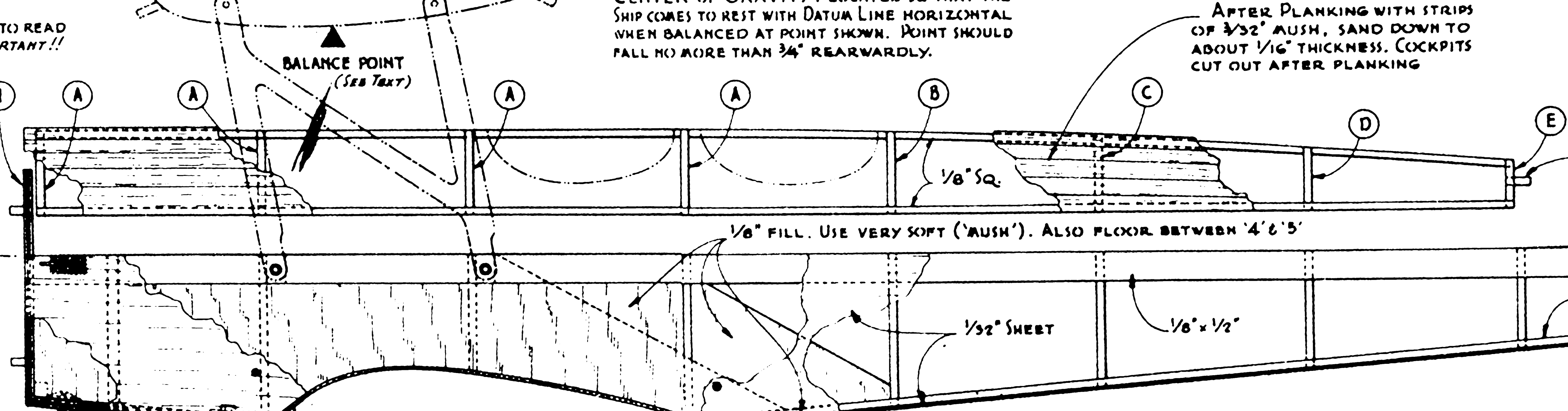
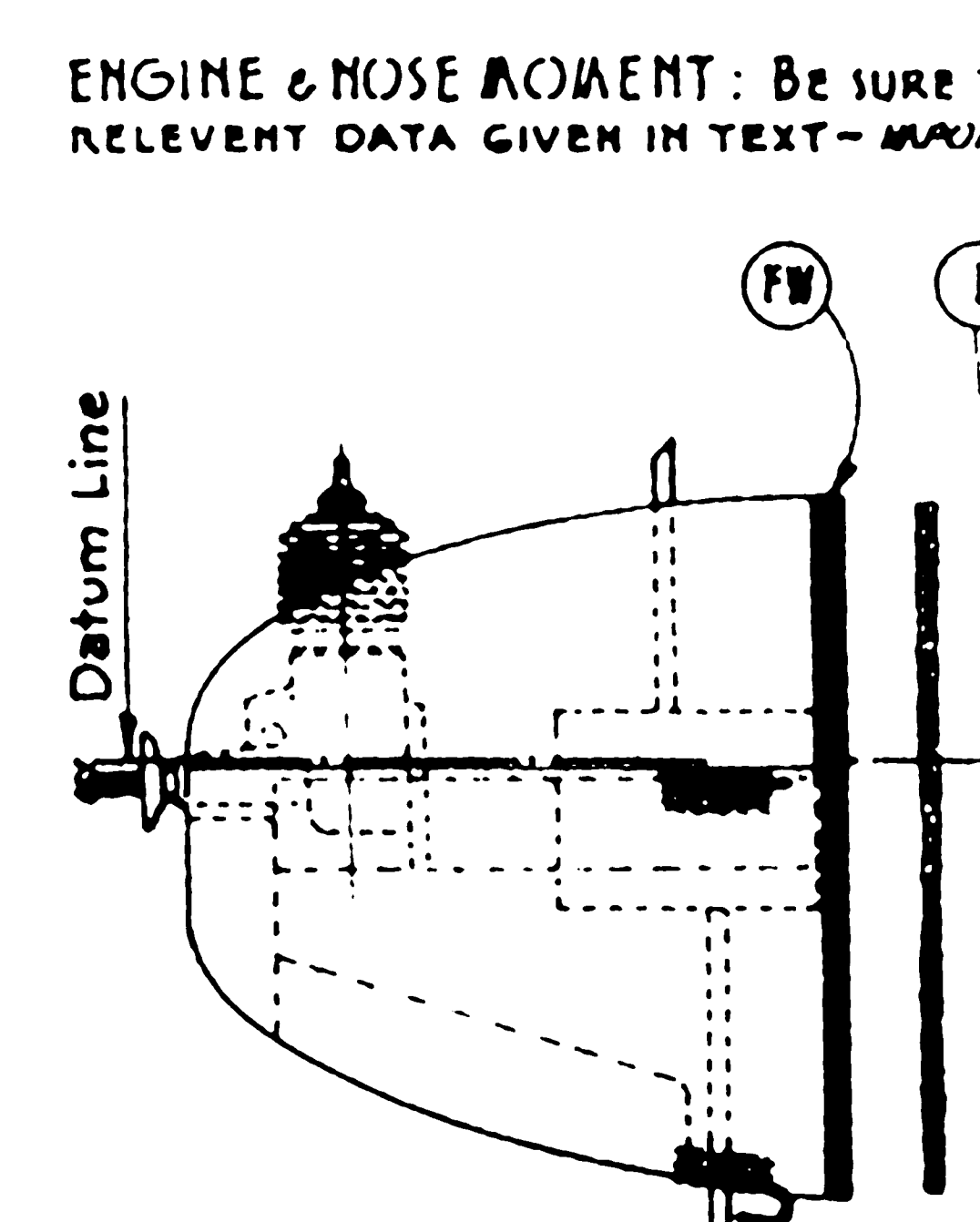
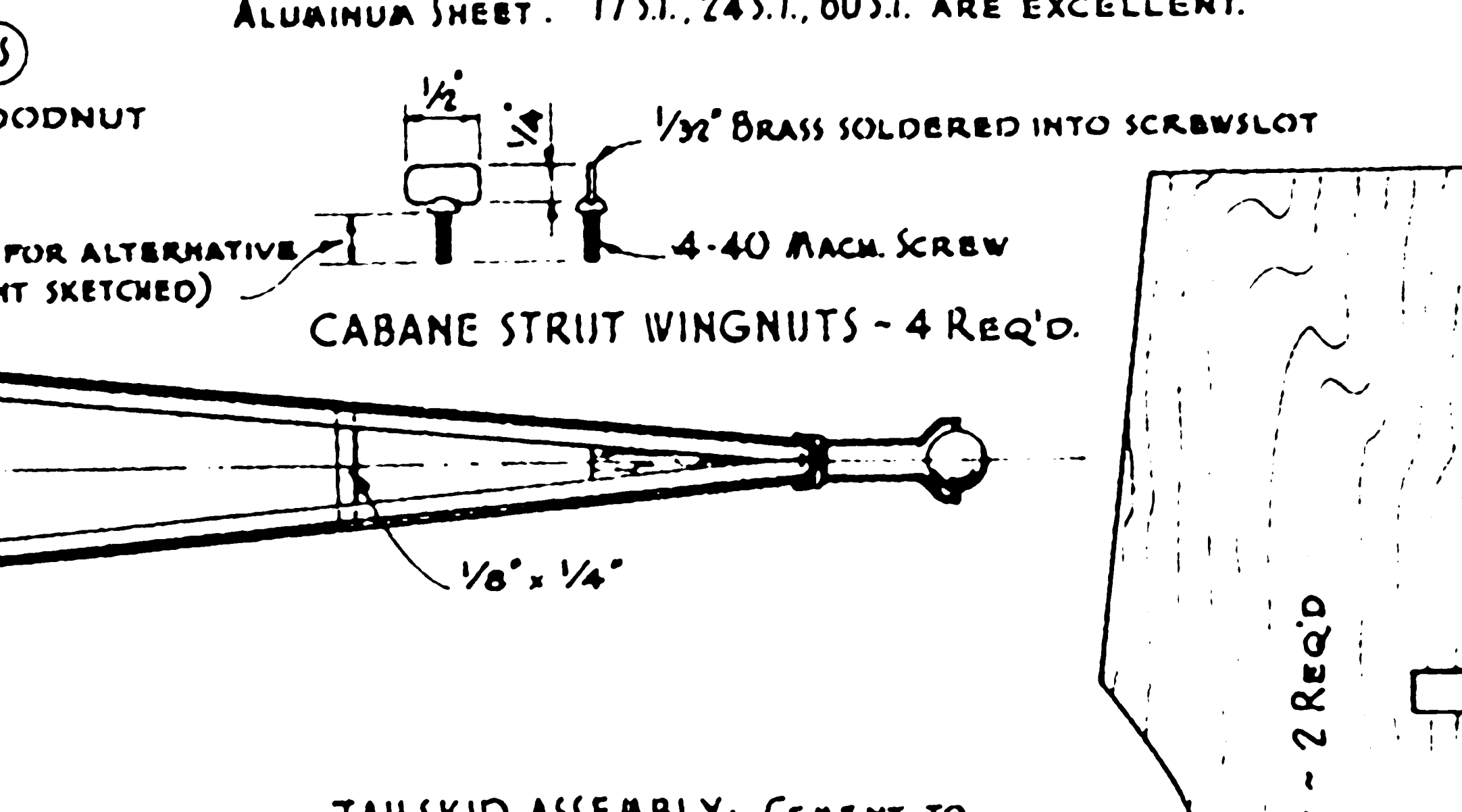
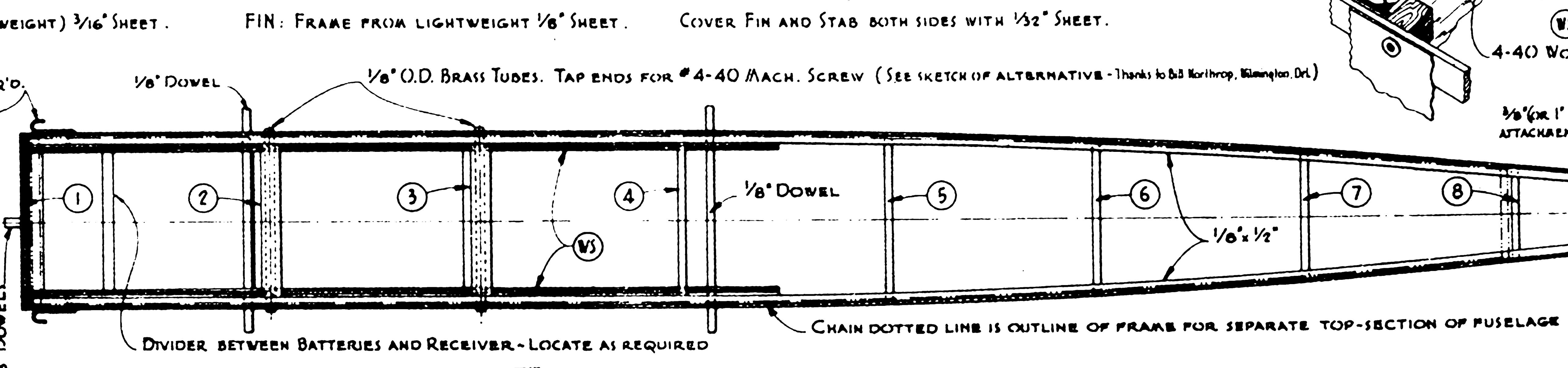
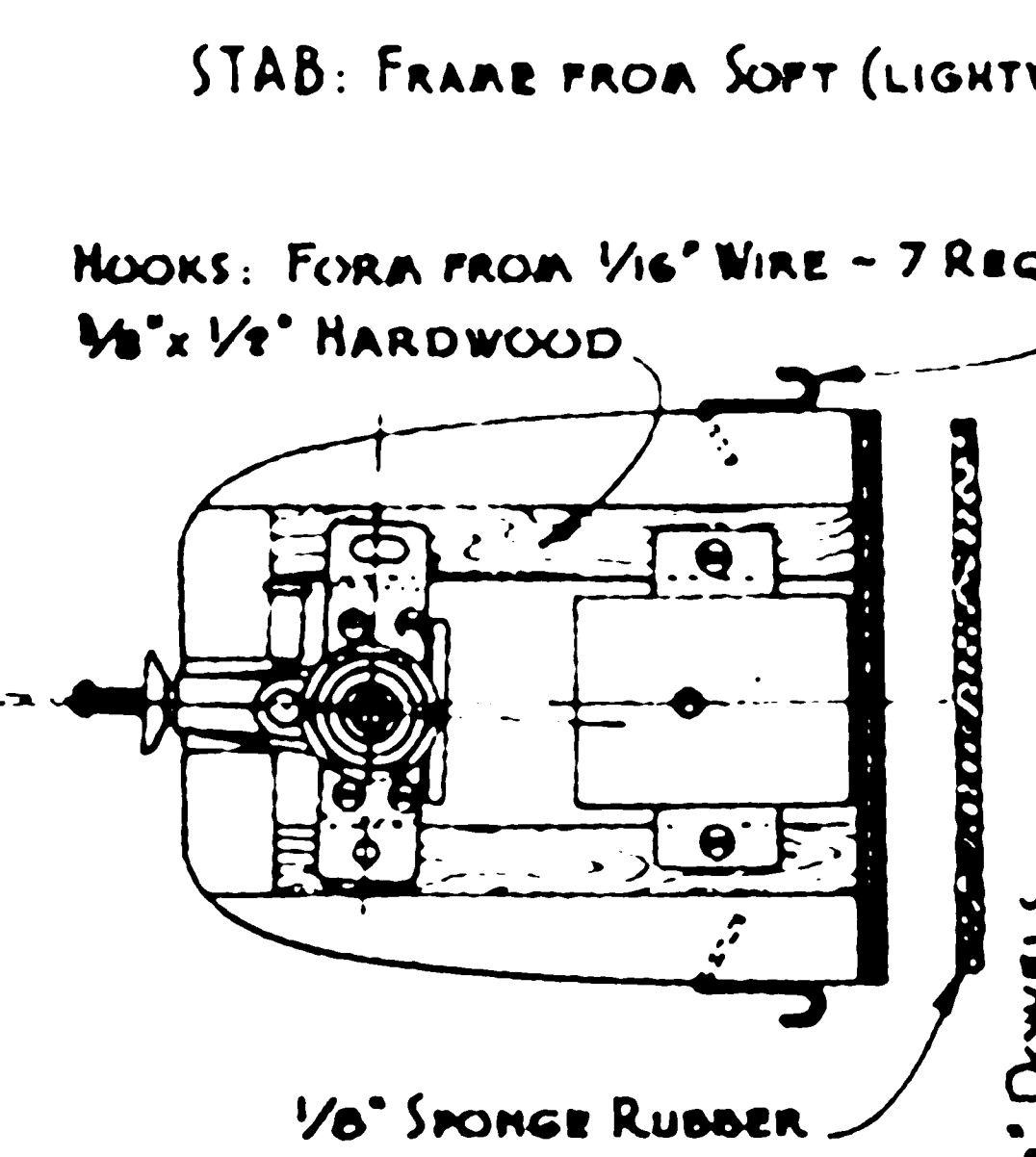
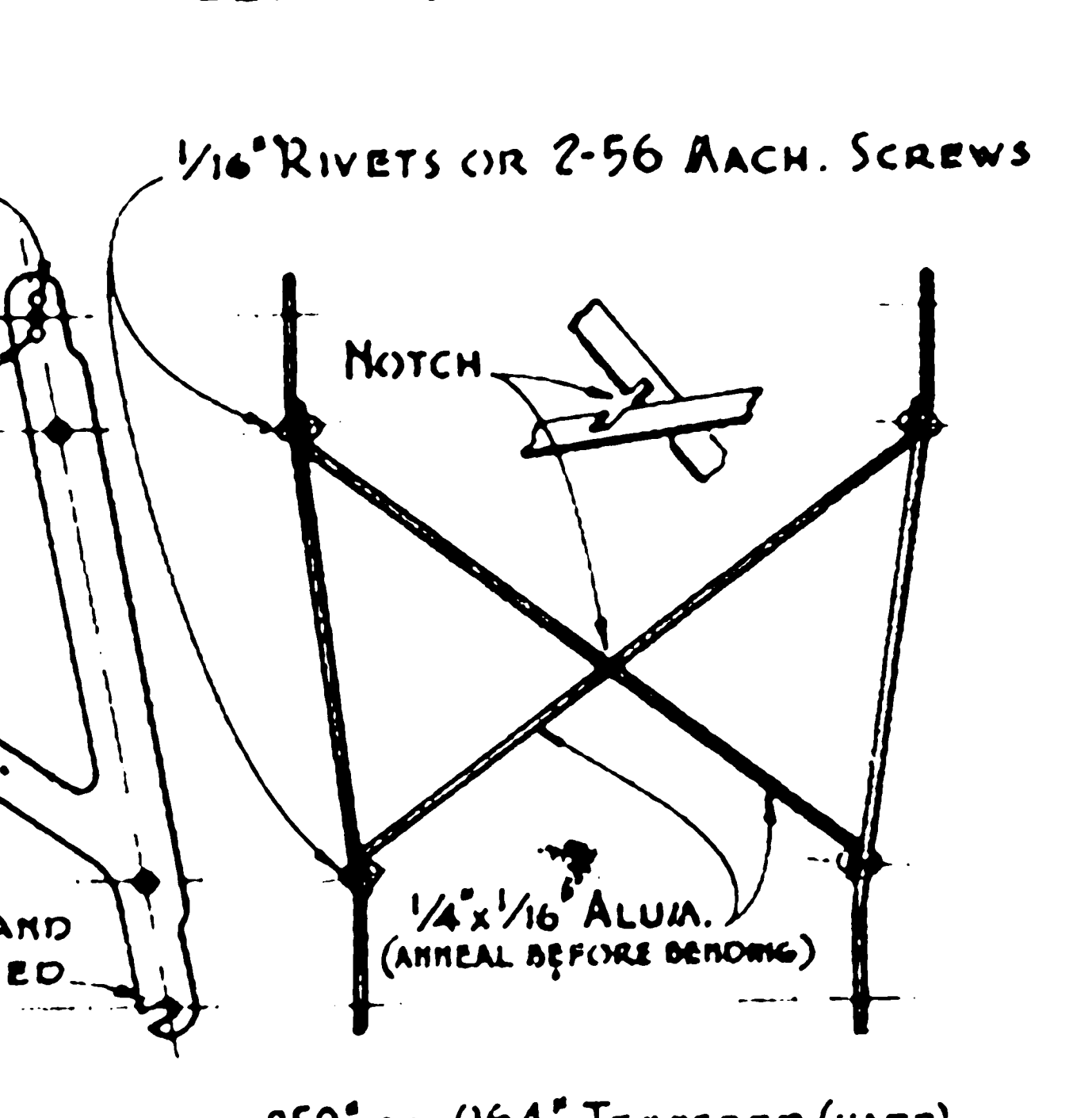
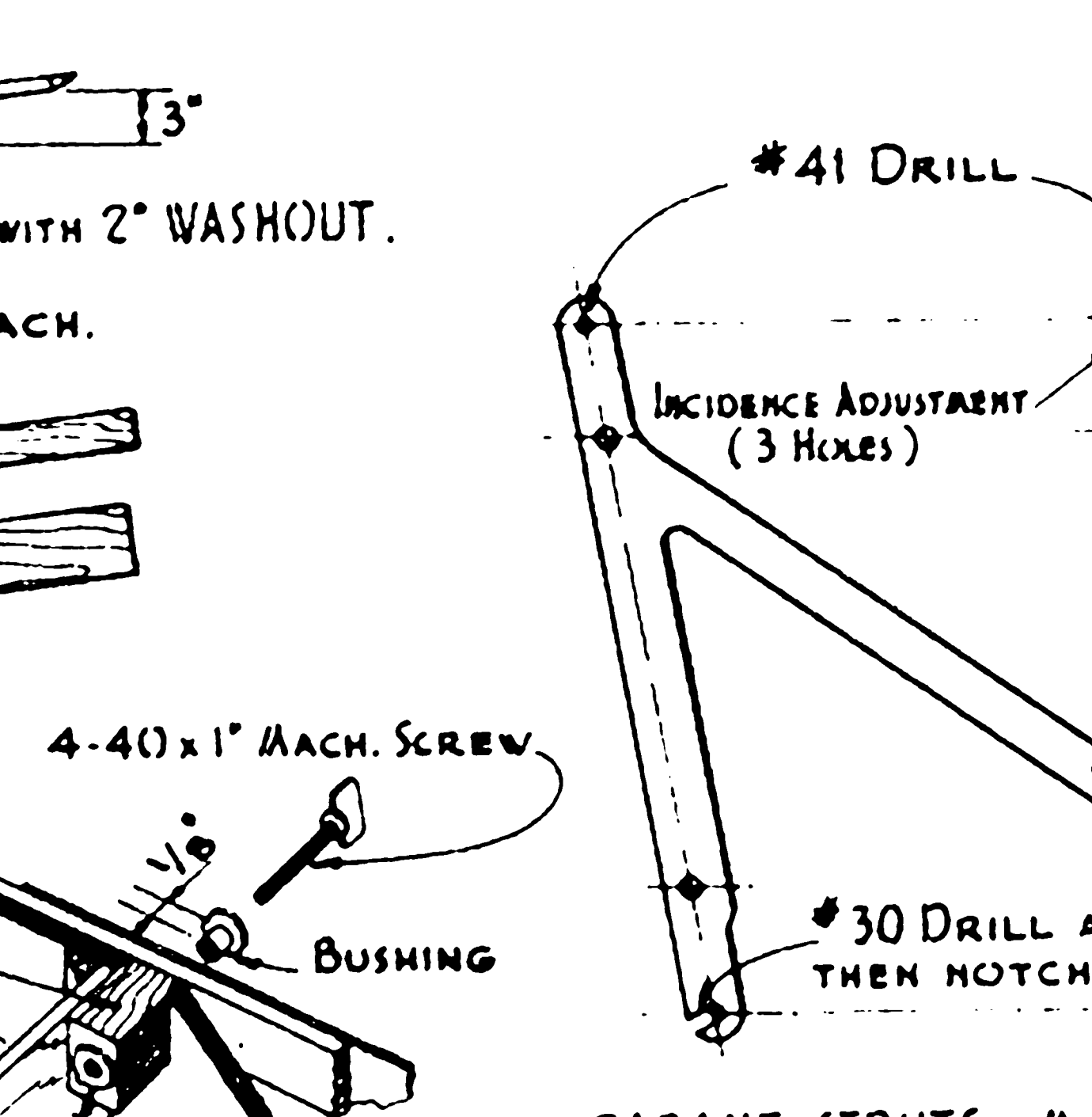
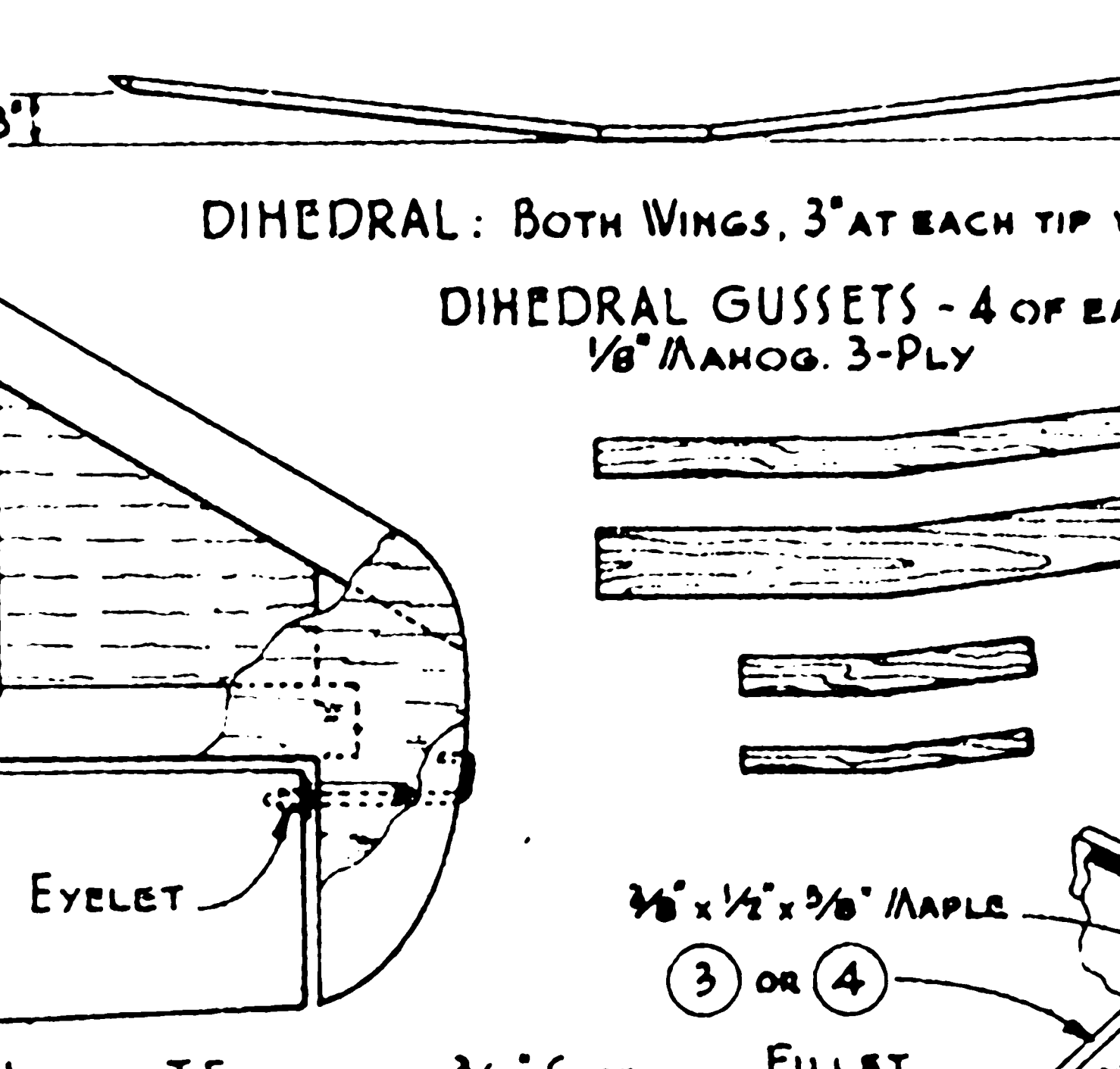
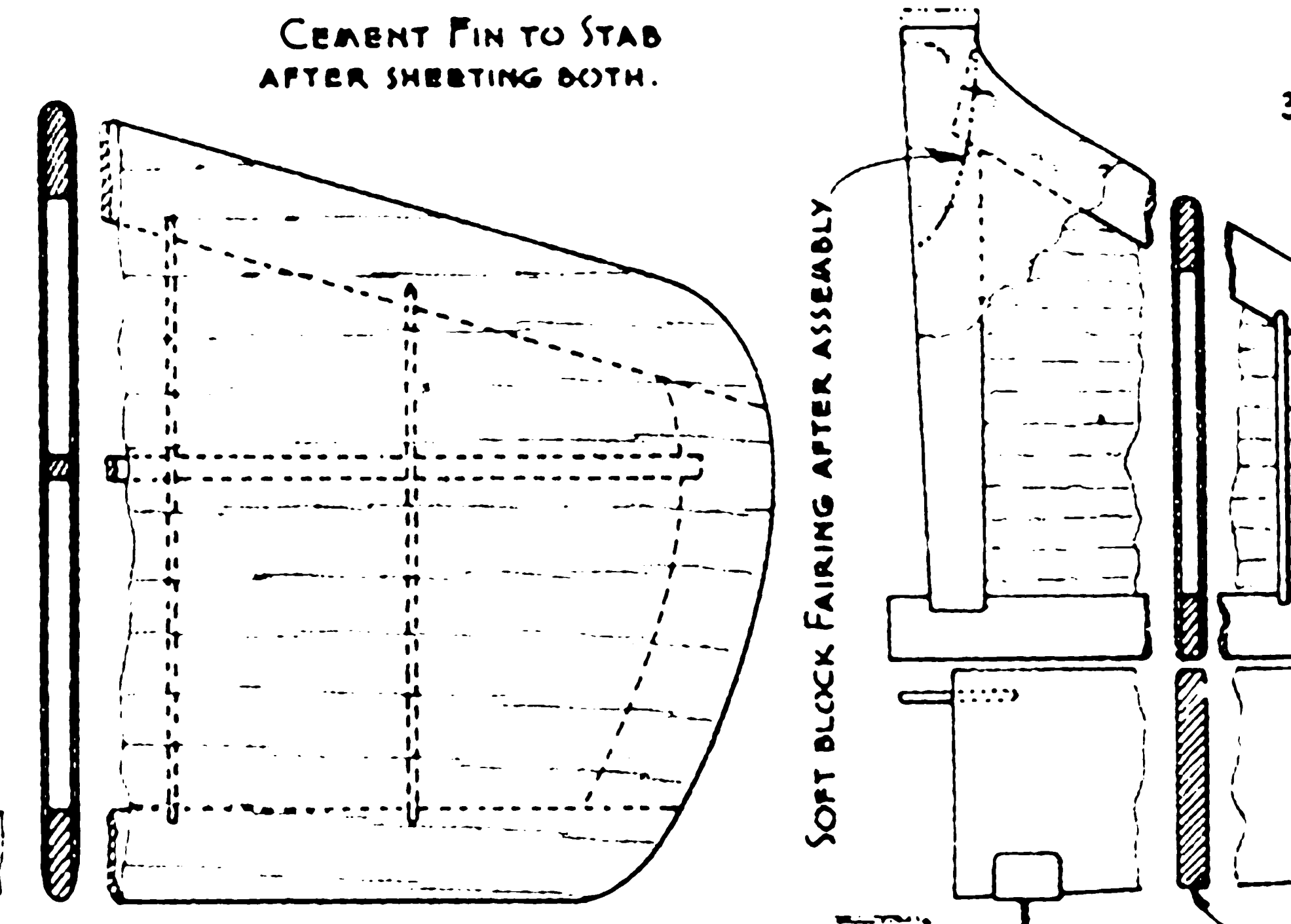
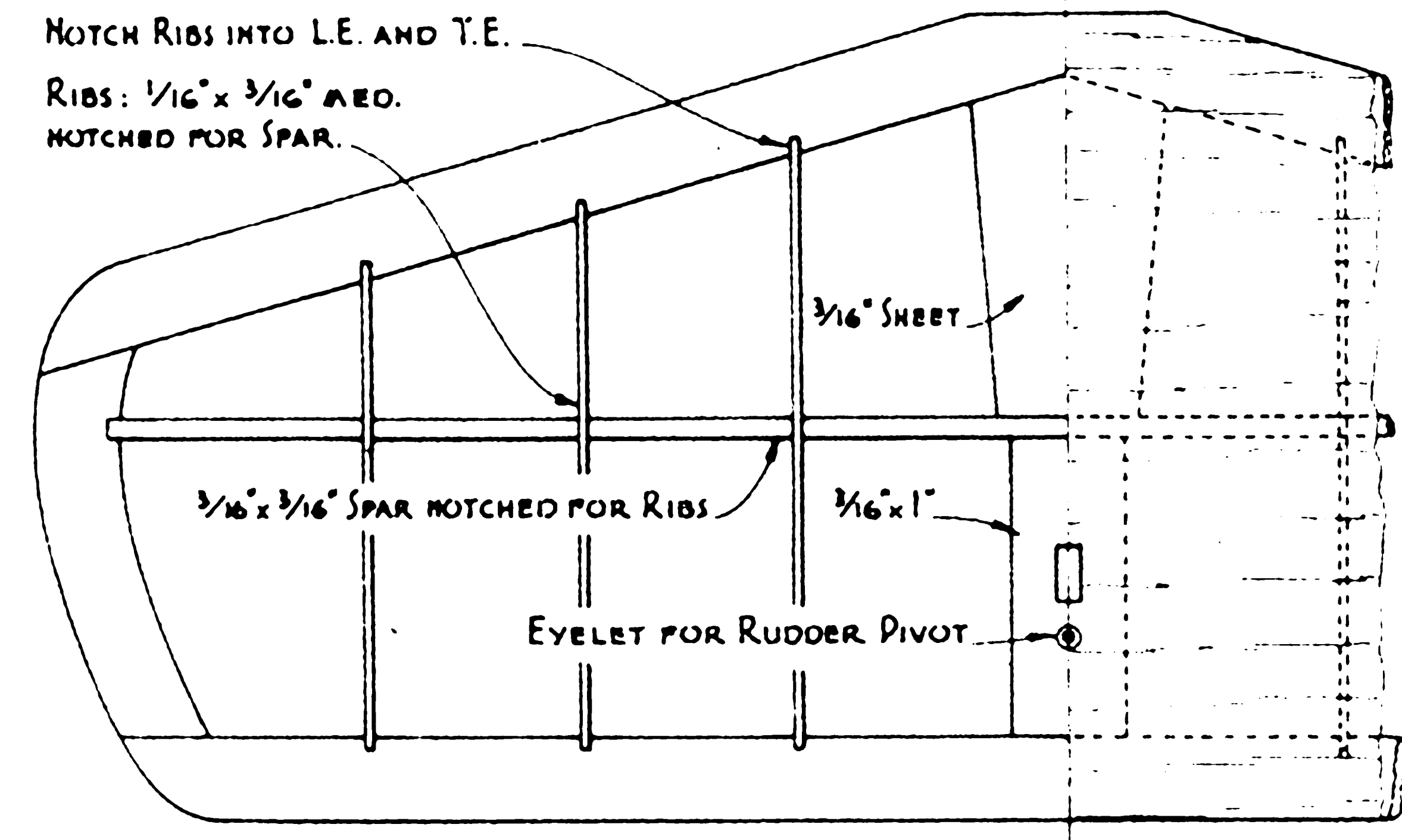
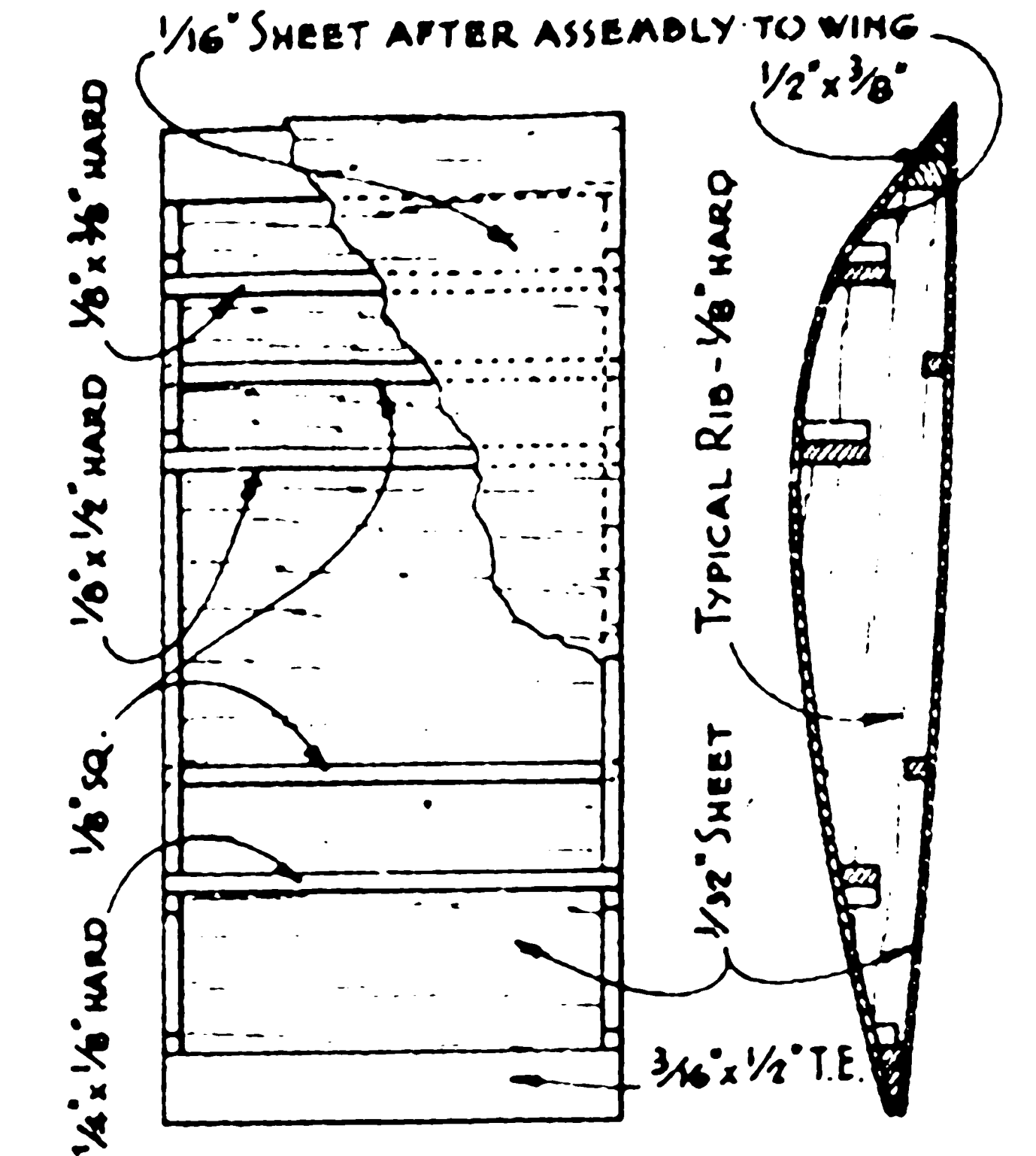
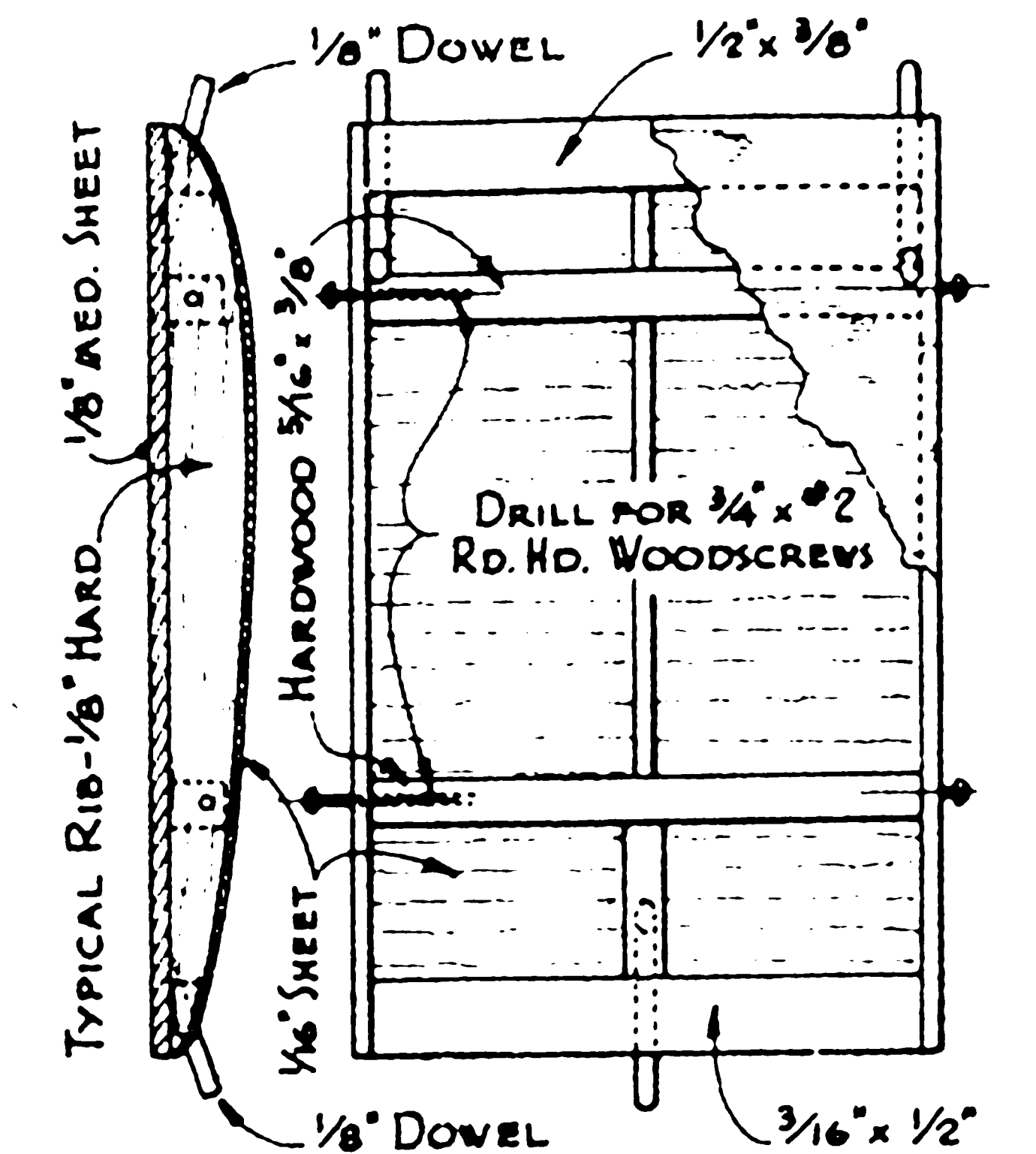
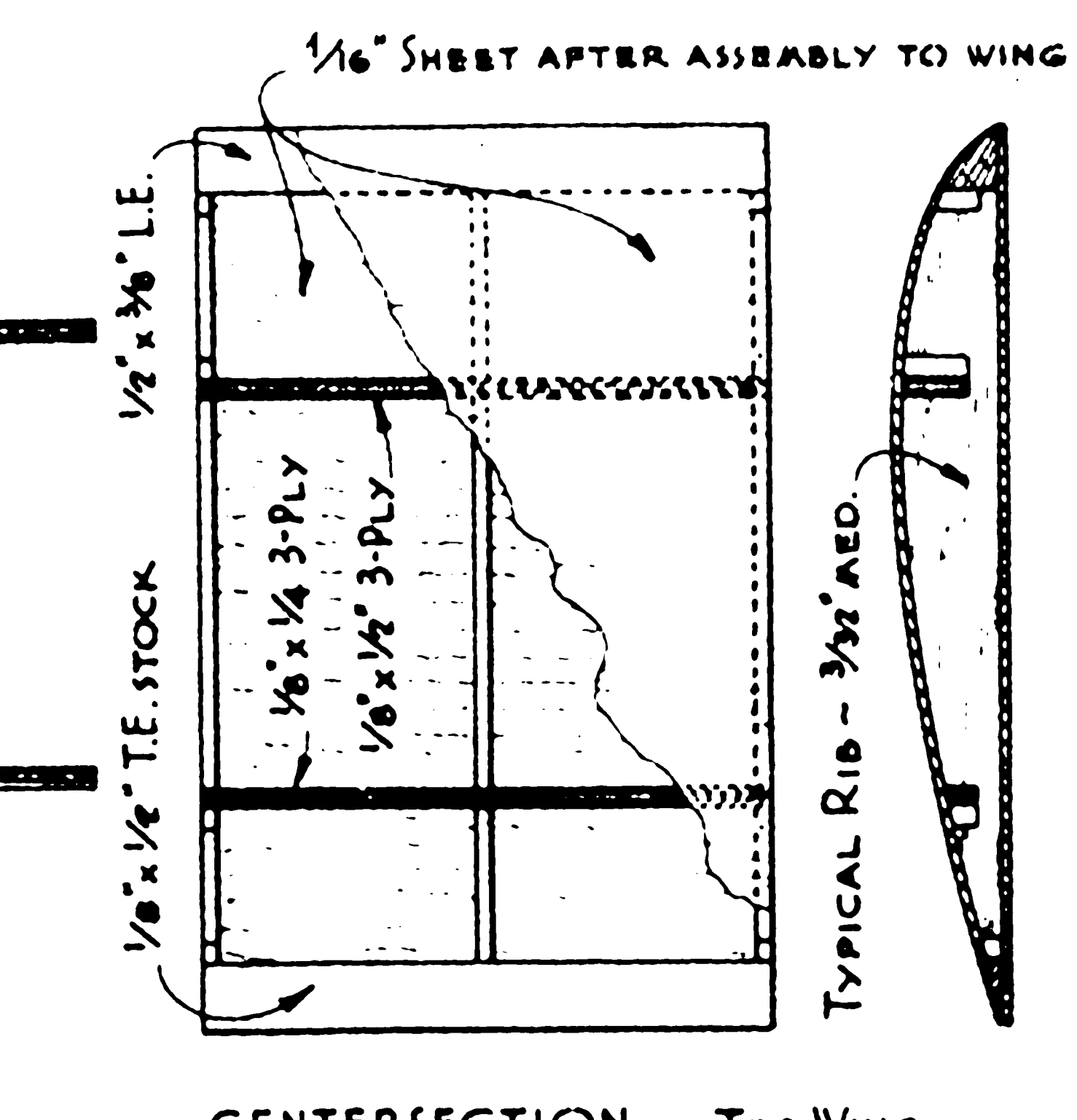
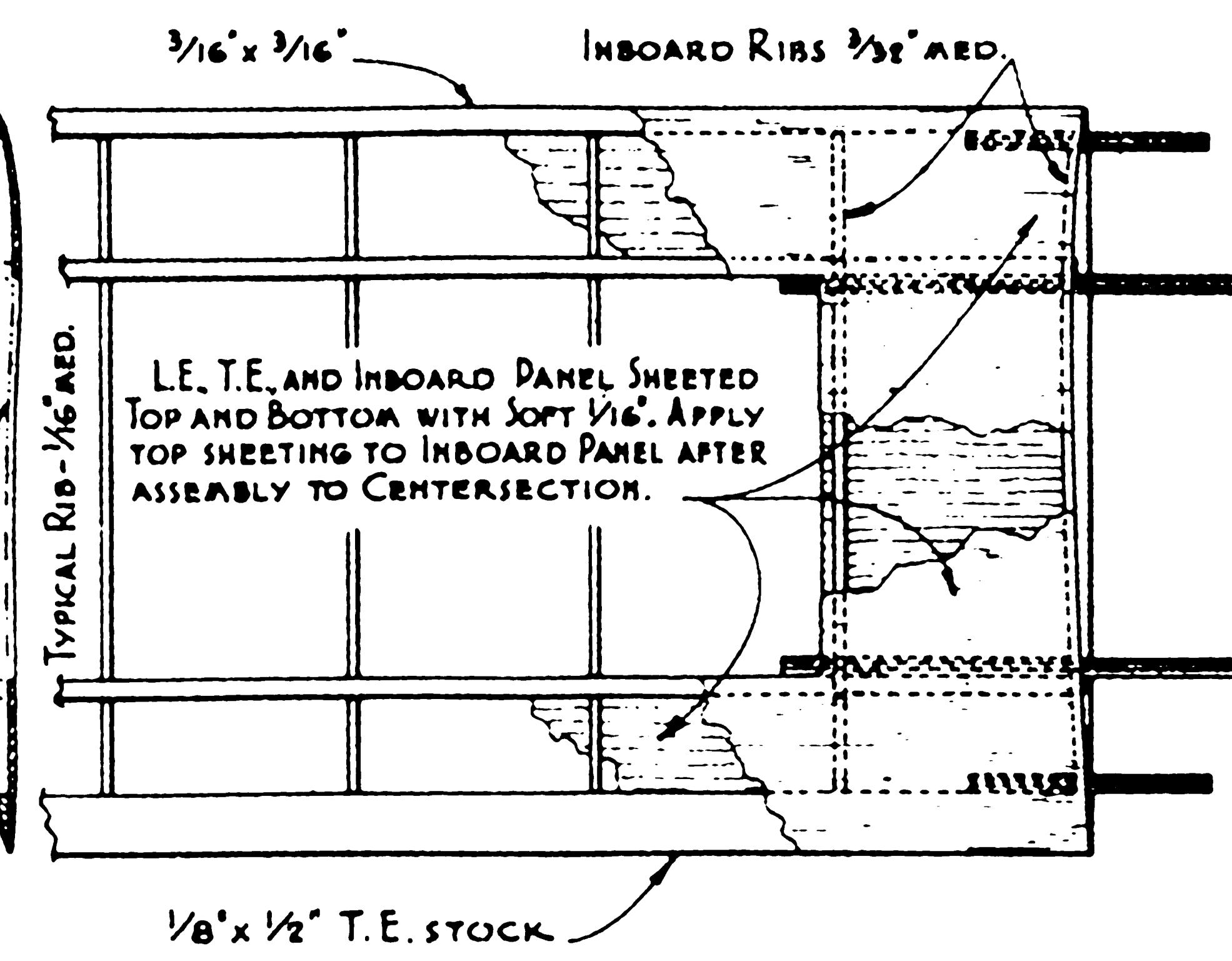
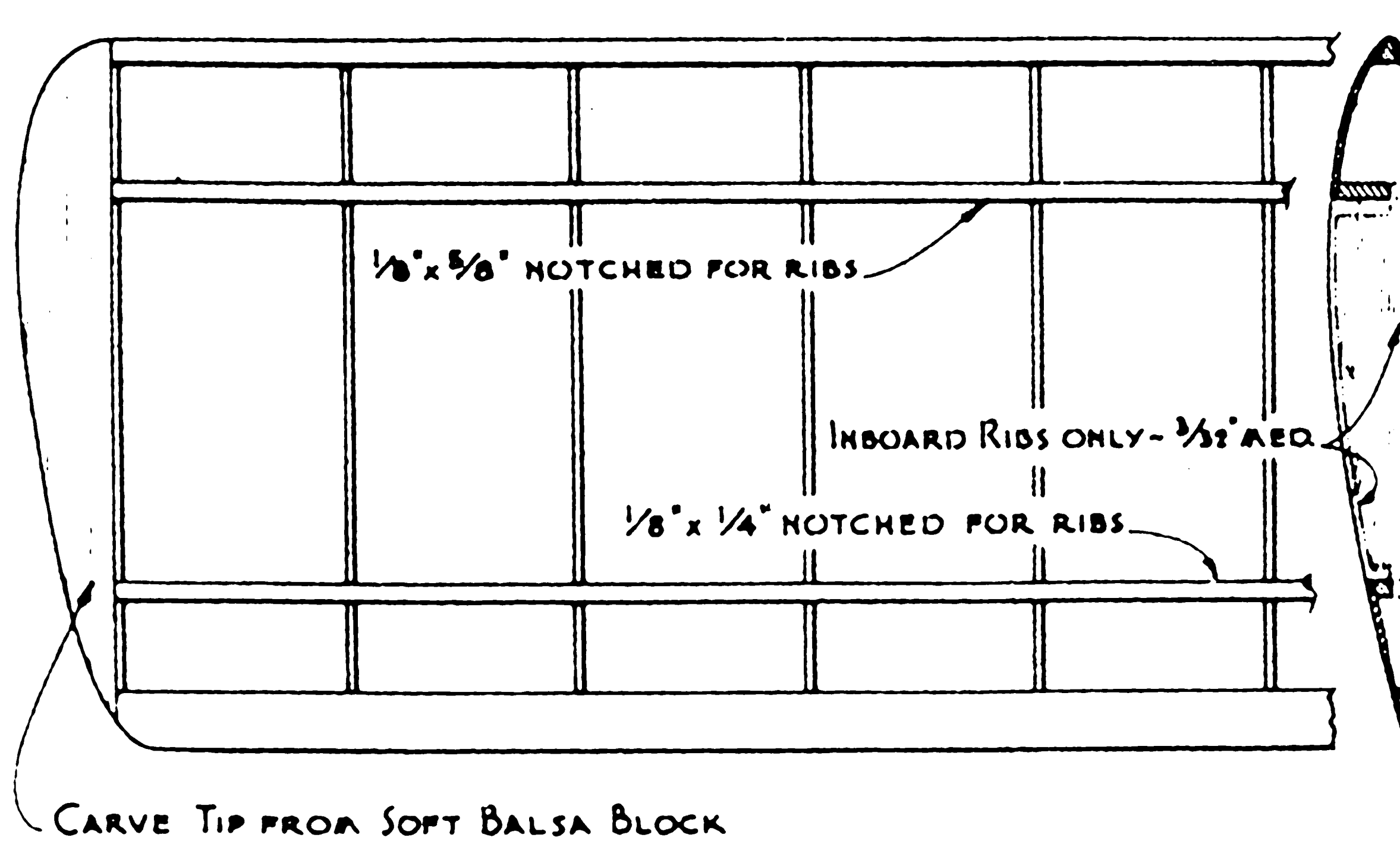

Drawn: J.S.L. - Checked: C.J. Vandenbelt.

2 1/2" AIRWHEELS

3/32" DRILL

"FW" 6" 1", 1/8" 3-PLY

1/8" DOWELS

FORMERS: #2 TO B AND B TO E, 1 OF EACH; A 4 REQ'D. 1/8" MED. SHEET, GRAIN DIRECTION AS SHOWN. (SEE NOTE)

J.S.L. Luck, 1956

Full-size plans for "The Barnstormer" are part of Plan #257 by Hobby Helpers, 770 Hunts Point Ave., New York 59, N. Y. (50c)