

# Bebe JODEL

## French "Home-Bilt" Lightplane for Control Line

By Hoh Fang-Chiun

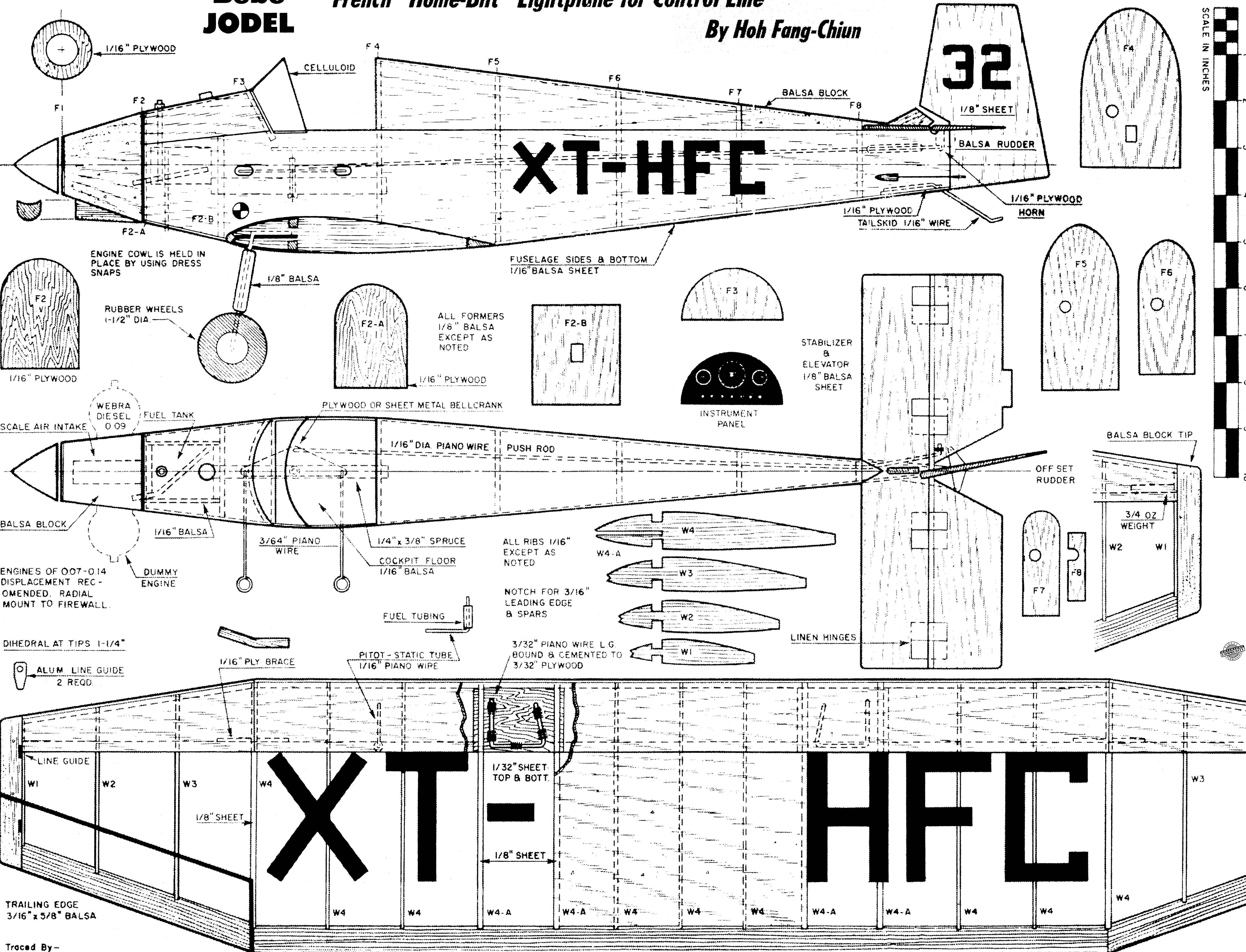
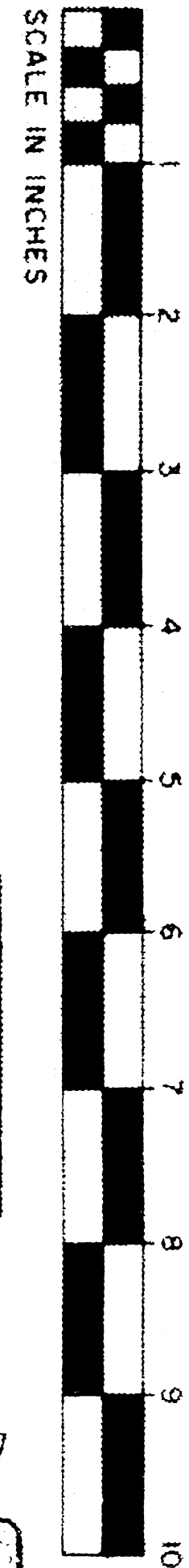

# XT-HFC

# 32

# XT-HFC

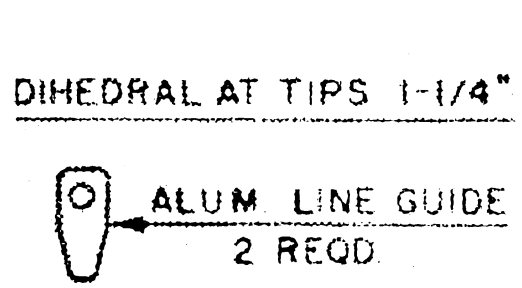
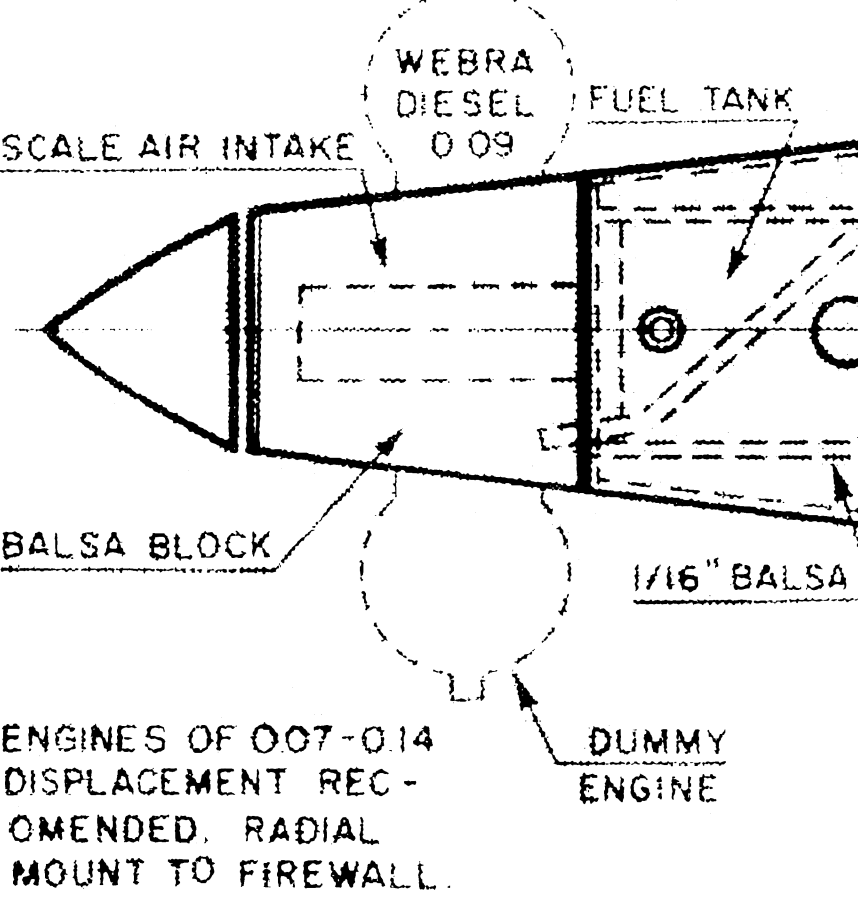
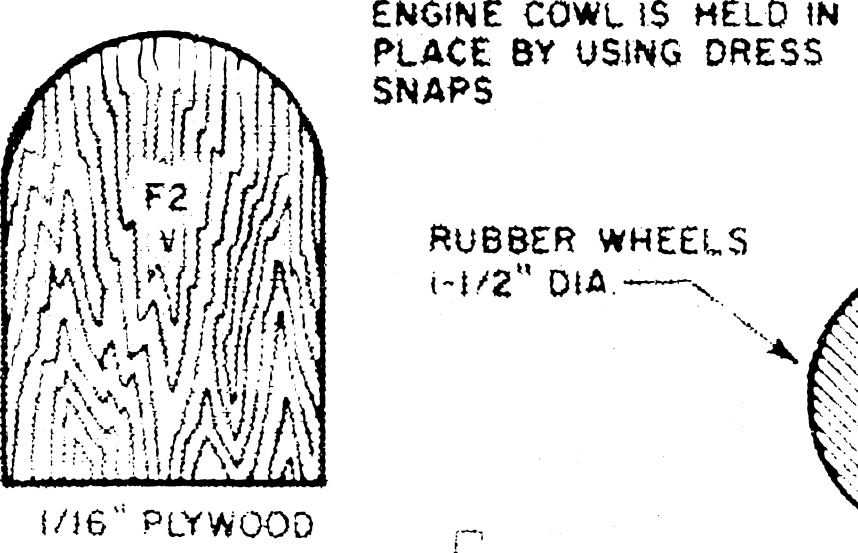
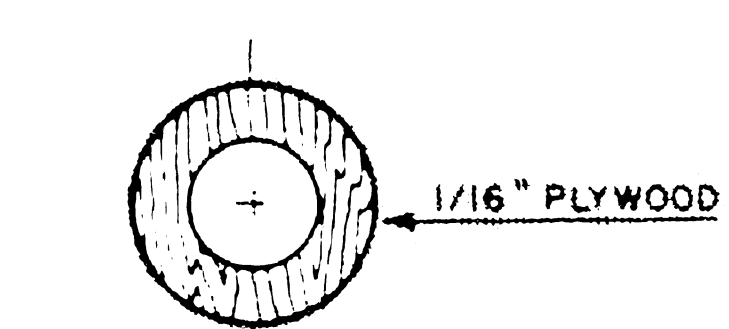

TRAILING EDGE  
3/16" x 5/8" Balsa

Traced By—  
E. G. THOMAS

ENGINE COWL IS HELD IN PLACE BY USING DRESS SNAPS

WEBRA DIESEL 0.09 FUEL TANK  
SCALE AIR INTAKE

ENGINES OF 007-014 DISPLACEMENT RECOMMENDED. RADIAL MOUNT TO FIREWALL.

DIHEDRAL AT TIPS 1-1/4"

ALUM. LINE GUIDE 2 REQD.

LINE GUIDE

1/8" SHEET

TRAILING EDGE 3/16" x 5/8" Balsa

Traced By—  
E. G. THOMAS

F1 F2 F3 CELLULOID F4 F5 F6 F7 F8

F2-A F2-B

1/8" Balsa

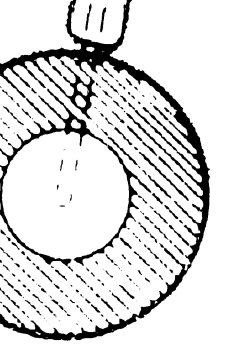

PLYWOOD OR SHEET METAL BELLCRANK

3/64" PIANO WIRE

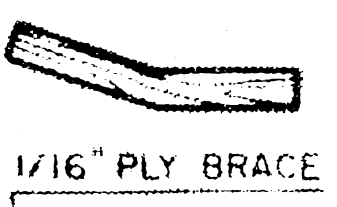

W1 W2 W3 W4

1/8" SHEET

W4

W4

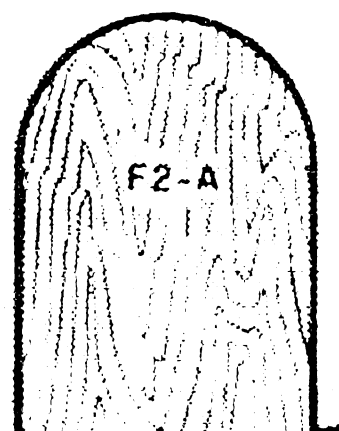

PLYWOOD OR SHEET METAL BELLCRANK

1/4" x 3/8" SPRUCE

PITOT-STATIC TUBE 1/16" PIANO WIRE

1/32" SHEET TOP & BOTT.

1/8" SHEET

W4

W4

ALL FORMERS 1/8" Balsa EXCEPT AS NOTED

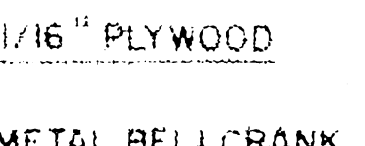

1/16" PLYWOOD

COCKPIT FLOOR 1/16" Balsa

3/32" PIANO WIRE L.G. BOUND & CEMENTED TO 3/32" PLYWOOD

1/32" SHEET TOP & BOTT.

1/8" SHEET

W4-A

W4-A

FUSELAGE SIDES & BOTTOM 1/16" Balsa SHEET

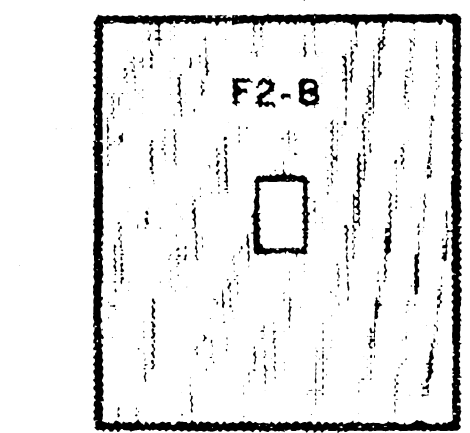

1/16" PLYWOOD

COCKPIT FLOOR 1/16" Balsa

3/32" PIANO WIRE L.G. BOUND & CEMENTED TO 3/32" PLYWOOD

1/32" SHEET TOP & BOTT.

1/8" SHEET

W4-A

W4-A

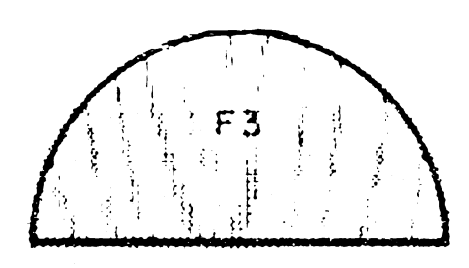

INSTRUMENT PANEL

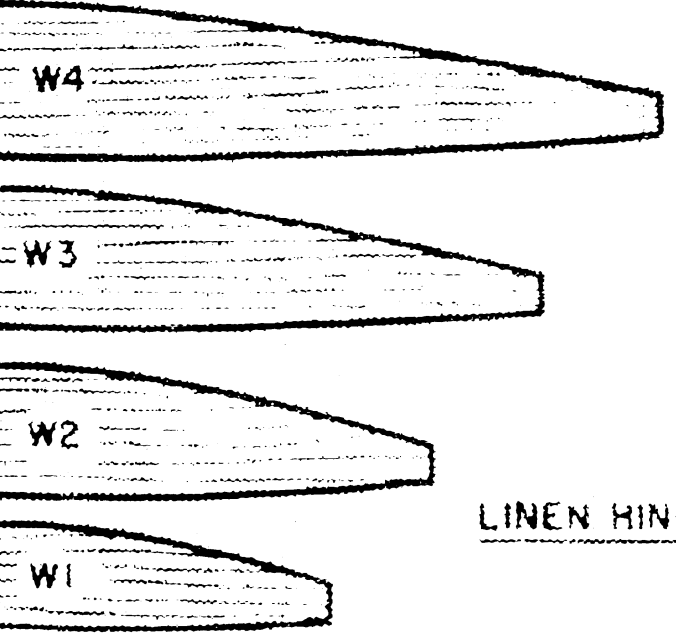

ALL RIBS 1/16" EXCEPT AS NOTED

NOTCH FOR 3/16" LEADING EDGE & SPARS

LINEN HINGES

W4

W4-A

W4

W4

STABILIZER & ELEVATOR 1/8" Balsa SHEET

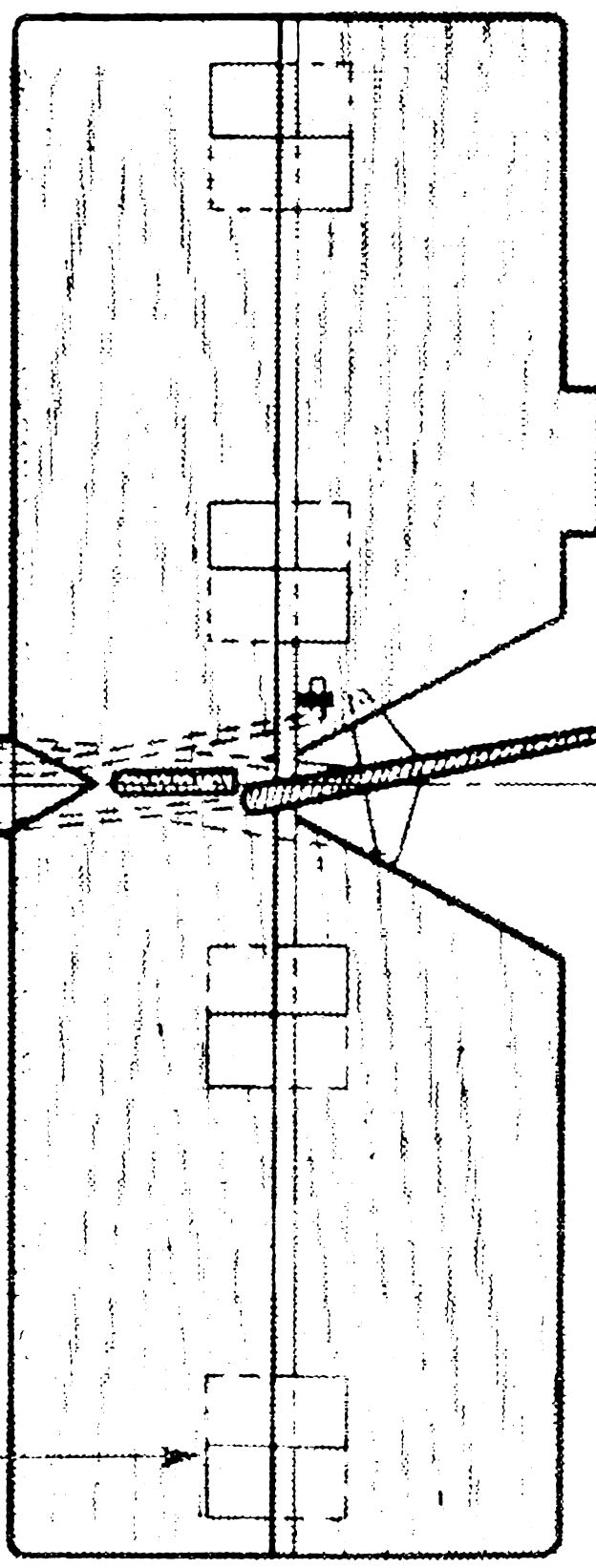

LINEN HINGES

W4

W4-A

W4

W4

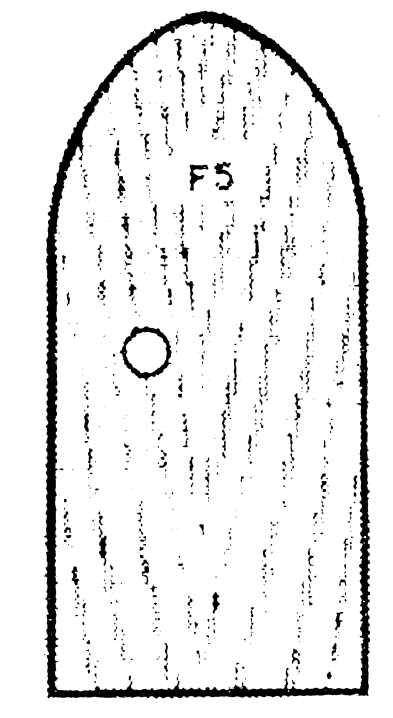

F5

1/16" PLYWOOD

PLYWOOD OR SHEET METAL BELLCRANK

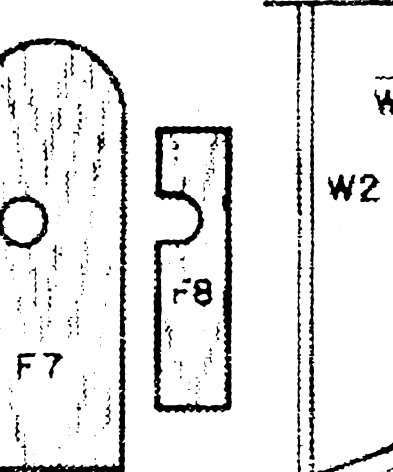

F7

1/16" PLYWOOD

W4

W4-A

W4

W4

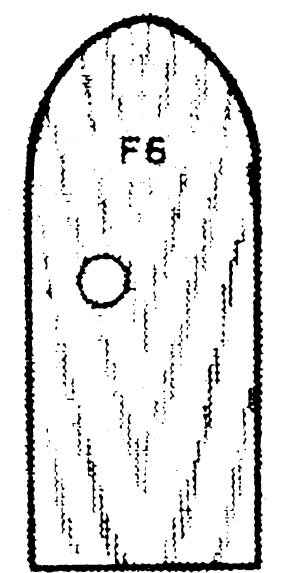

F6

1/16" PLYWOOD

PLYWOOD OR SHEET METAL BELLCRANK



F8

1/16" PLYWOOD

W4

W4-A

W4

W4

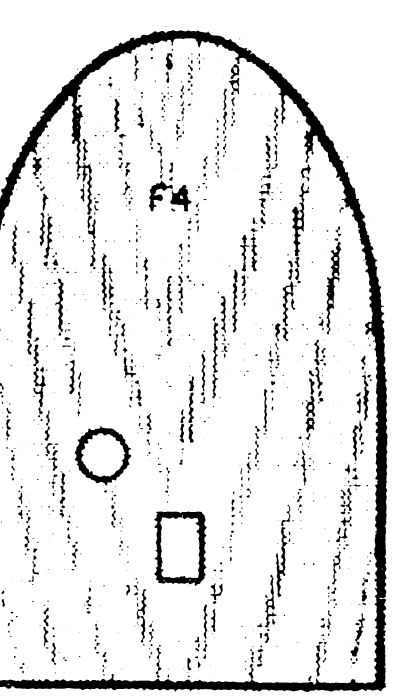

F4

1/8" SHEET

Balsa Rudder

1/16" PLYWOOD HORN

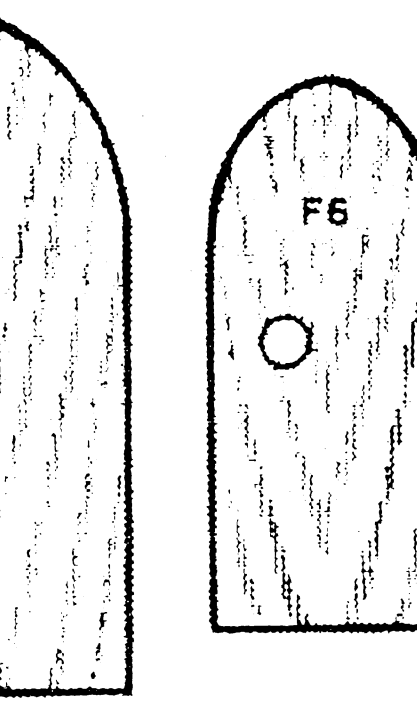

Balsa Block Tip

OFF SET RUDDER

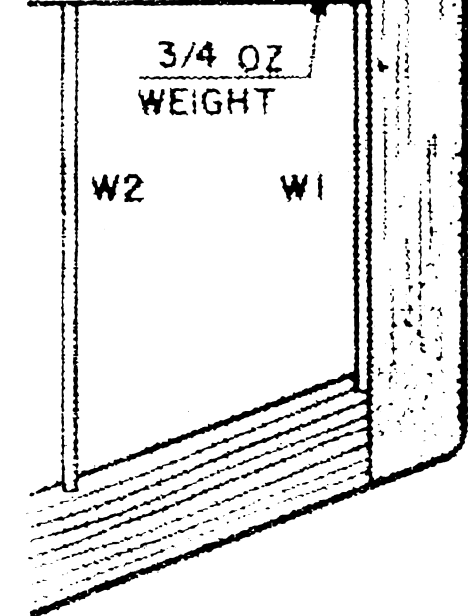

3/4 OZ WEIGHT

W2 W1

F7

1/16" PLYWOOD

W4

W4-A

W4

W4

Balsa Block

F8

1/8" SHEET

Balsa Rudder

1/16" PLYWOOD TAILSKID 1/16" WIRE

1/16" PLYWOOD HORN

STABILIZER & ELEVATOR 1/8" Balsa SHEET

OFF SET RUDDER

3/4 OZ WEIGHT

W2 W1

F7

1/16" PLYWOOD

W4

W4-A

W4

W4

# XT-HFC

# 32

# XT-HFC

ENGINE COWL IS HELD IN PLACE BY USING DRESS SNAPS

WEBRA DIESEL 0.09 FUEL TANK  
SCALE AIR INTAKE

ENGINES OF 007-014 DISPLACEMENT RECOMMENDED. RADIAL MOUNT TO FIREWALL.

DIHEDRAL AT TIPS 1-1/4"

ALUM. LINE GUIDE 2 REQD.

LINE GUIDE

1/8" SHEET

TRAILING EDGE 3/16" x 5/8" Balsa

Traced By—  
E. G. THOMAS

F1 F2 F3 CELLULOID F4 F5 F6 F7 F8

F2-A F2-B

1/8" Balsa

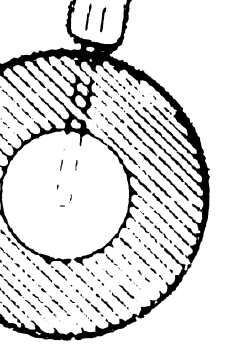

PLYWOOD OR SHEET METAL BELLCRANK

3/64" PIANO WIRE

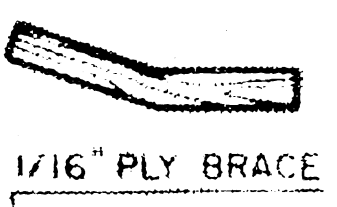

W1 W2 W3 W4

1/8" SHEET

W4

W4

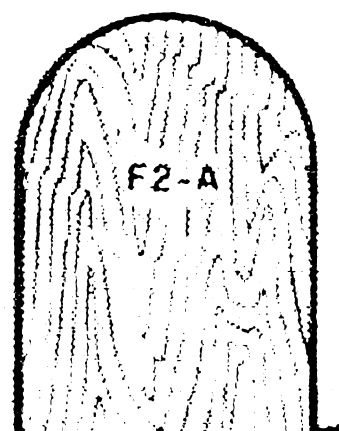

PLYWOOD OR SHEET METAL BELLCRANK

1/4" x 3/8" SPRUCE

PITOT-STATIC TUBE 1/16" PIANO WIRE

1/32" SHEET TOP & BOTT.

1/8" SHEET

W4

W4

ALL FORMERS 1/8" Balsa EXCEPT AS NOTED

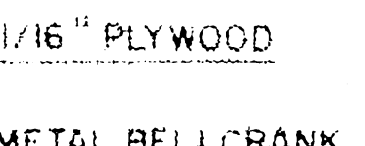

1/16" PLYWOOD

COCKPIT FLOOR 1/16" Balsa

3/32" PIANO WIRE L.G. BOUND & CEMENTED TO 3/32" PLYWOOD

1/32" SHEET TOP & BOTT.

1/8" SHEET

W4-A

W4-A

FUSELAGE SIDES & BOTTOM 1/16" Balsa SHEET

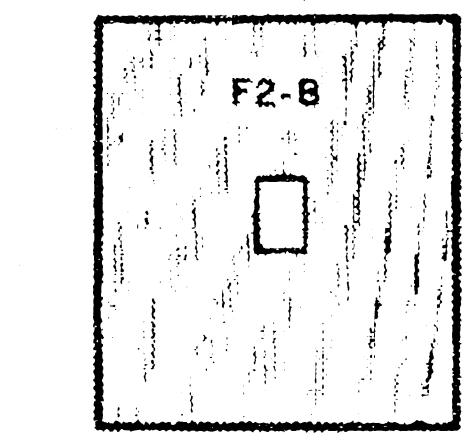

1/16" PLYWOOD

COCKPIT FLOOR 1/16" Balsa

3/32" PIANO WIRE L.G. BOUND & CEMENTED TO 3/32" PLYWOOD

1/32" SHEET TOP & BOTT.

1/8" SHEET

W4-A

W4-A

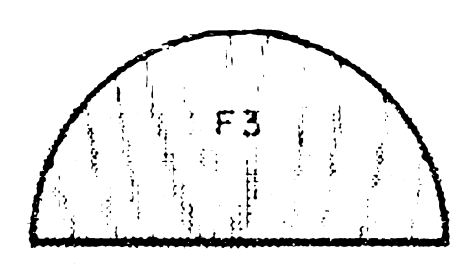

INSTRUMENT PANEL

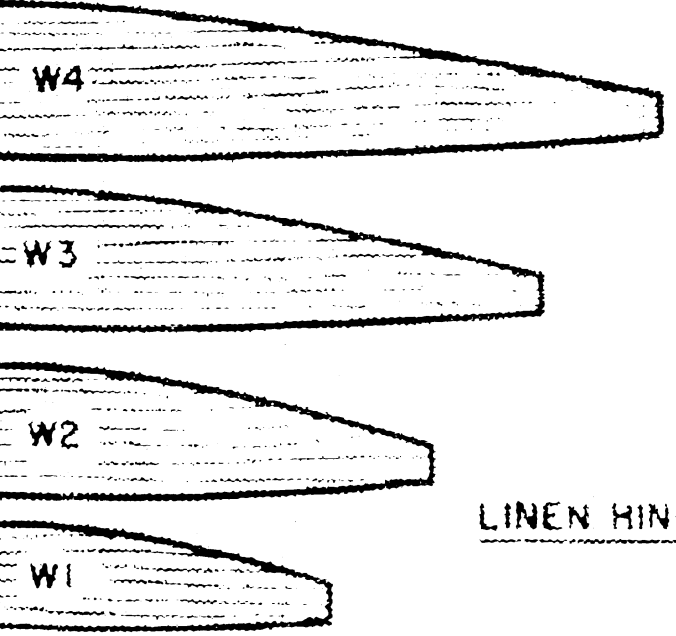

ALL RIBS 1/16" EXCEPT AS NOTED

NOTCH FOR 3/16" LEADING EDGE & SPARS

LINEN HINGES

W4

W4-A

W4

W4

STABILIZER & ELEVATOR 1/8" Balsa SHEET

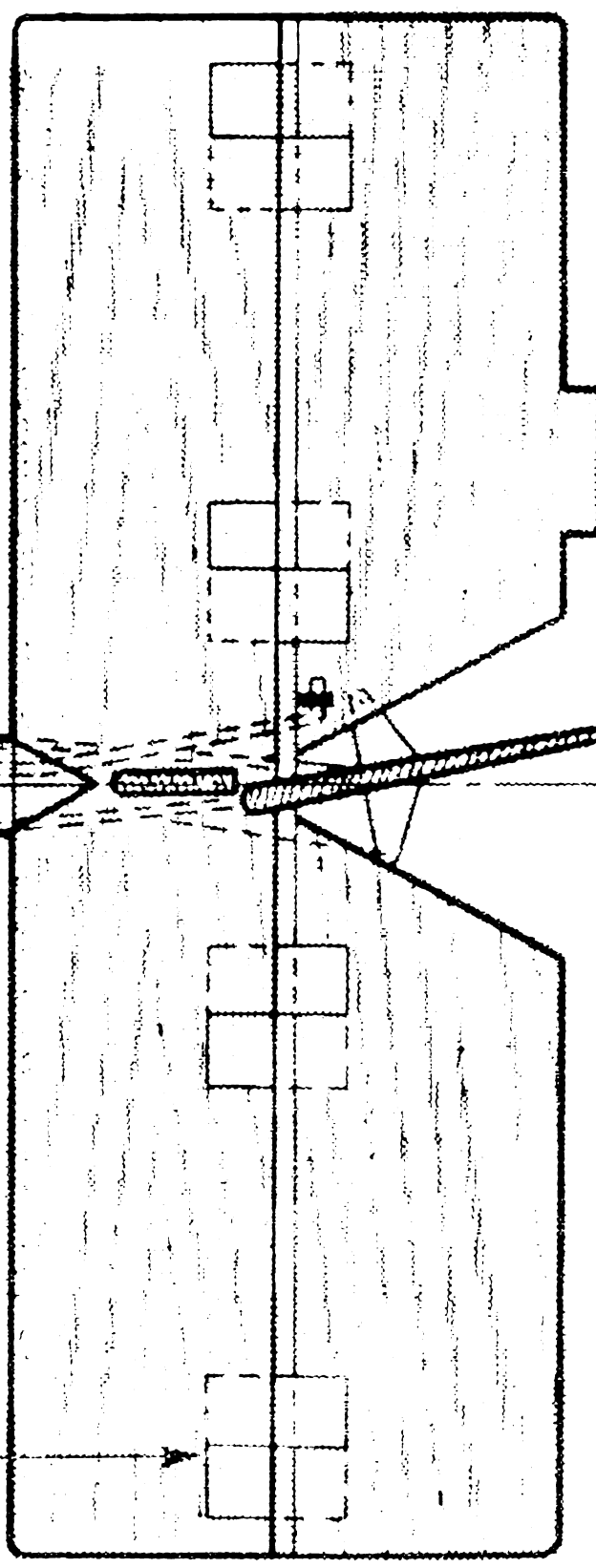

LINEN HINGES

W4

W4-A

W4

W4

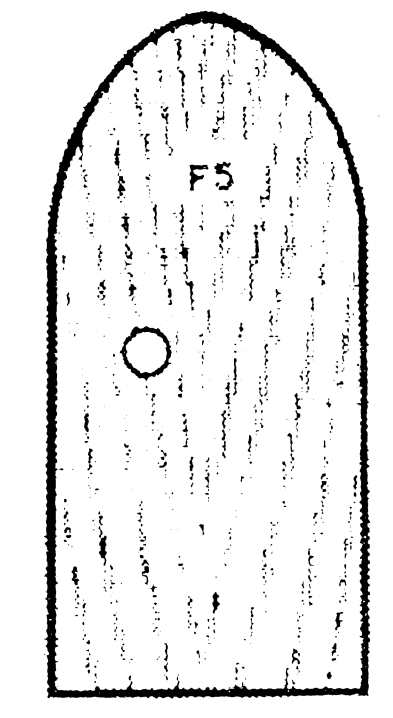

F5

1/16" PLYWOOD

PLYWOOD OR SHEET METAL BELLCRANK

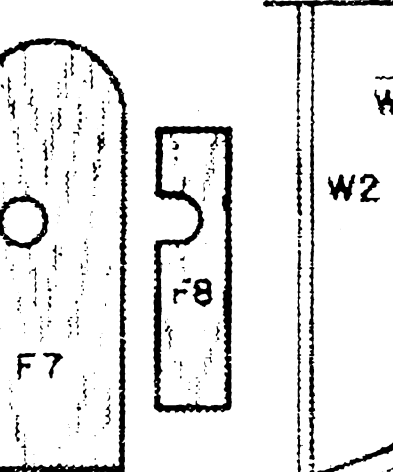

F7

1/16" PLYWOOD

W4

W4-A

W4

W4

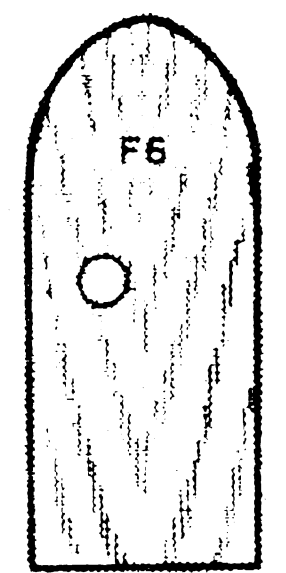

F6

1/16" PLYWOOD

PLYWOOD OR SHEET METAL BELLCRANK



F8

1/16" PLYWOOD

W4

W4-A

W4

W4

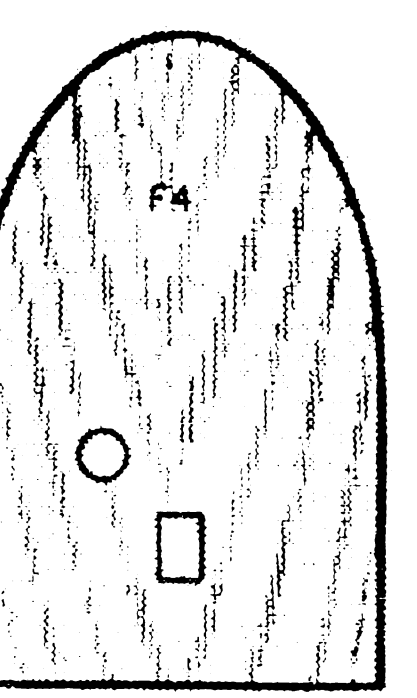

F4

1/8" SHEET

Balsa Rudder

1/16" PLYWOOD HORN

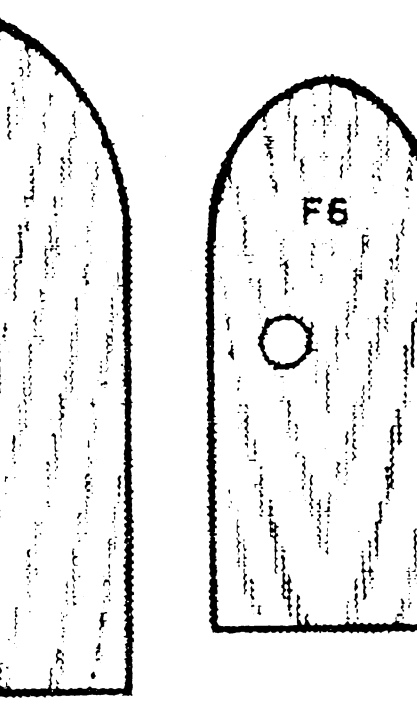

Balsa Block Tip

OFF SET RUDDER

3/4 OZ WEIGHT

W2 W1

F7

1/16" PLYWOOD

W4

W4-A

W4

W4

Balsa Block

F8

1/8" SHEET

Balsa Rudder

1/16" PLYWOOD TAILSKID 1/16" WIRE

1/16" PLYWOOD HORN

STABILIZER & ELEVATOR 1/8" Balsa SHEET

OFF SET RUDDER

3/4 OZ WEIGHT

W2 W1

F7

1/16" PLYWOOD

W4

W4-A

W4

W4

# XT-HFC

# 32

# XT-HFC

ENGINE COWL IS HELD IN PLACE BY USING DRESS SNAPS

WEBRA DIESEL 0.09 FUEL TANK  
SCALE AIR INTAKE

ENGINES OF 007-014 DISPLACEMENT RECOMMENDED. RADIAL MOUNT TO FIREWALL.

DIHEDRAL AT TIPS 1-1/4"

ALUM. LINE GUIDE 2 REQD.

LINE GUIDE

1/8" SHEET

TRAILING EDGE 3/16" x 5/8" Balsa

Traced By—  
E. G. THOMAS

F1 F2 F3 CELLULOID F4 F5 F6 F7 F8

F2-A F2-B

1/8" Balsa

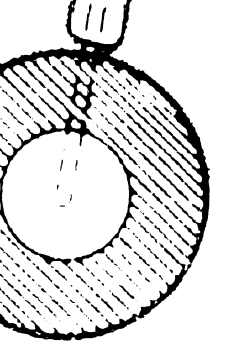

PLYWOOD OR SHEET METAL BELLCRANK

3/64" PIANO WIRE

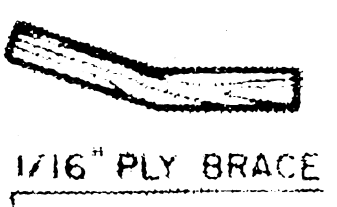

W1 W2 W3 W4

1/8" SHEET

W4

W4

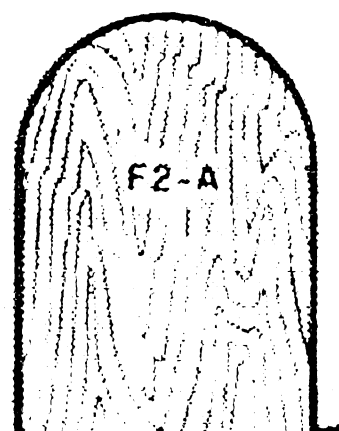

PLYWOOD OR SHEET METAL BELLCRANK

1/4" x 3/8" SPRUCE

PITOT-STATIC TUBE 1/16" PIANO WIRE

1/32" SHEET TOP & BOTT.

1/8" SHEET

W4

W4

ALL FORMERS 1/8" Balsa EXCEPT AS NOTED

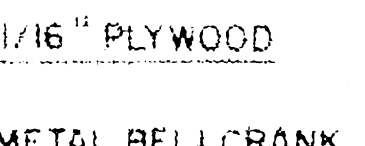

1/16" PLYWOOD

COCKPIT FLOOR 1/16" Balsa

3/32" PIANO WIRE L.G. BOUND & CEMENTED TO 3/32" PLYWOOD

1/32" SHEET TOP & BOTT.

1/8" SHE