

# SOPWITH BEE

HARRY HAWKER'S AEROBATIC AIRCRAFT, 1916

SCALE 1:8, FOR GEARED SP 400 MOTORS.  
ORIGINAL RESEARCH, DESIGN AND  
DRAWING BY MIKE ROACH

COLOUR NOTES. CAMOUFLAGE AND MARKINGS WERE AS CLOSE TO OPERATIONAL AIRCRAFT AS POSSIBLE, SO UPPER SURFACES WOULD HAVE BEEN PC10 AND LOWER SURFACES NATURAL FABRIC. ALLOY COWL AND SIDE PANELS WERE BURNISHED. THE FUSELAGE COCKPIT COAMING IS PLY THE WHITE SERIAL PANEL WAS BLANK. THE WHEEL COVERS WERE NATURAL FABRIC

ALL MATERIALS ARE MEDIUM/SOFT Balsa WOOD UNLESS STATED. ALL DIMENSIONS ARE IN MM. LP = LITEPLY BASS = BASSWOOD

SCALE DIHEDRAL 15.0 AT TIP RIB

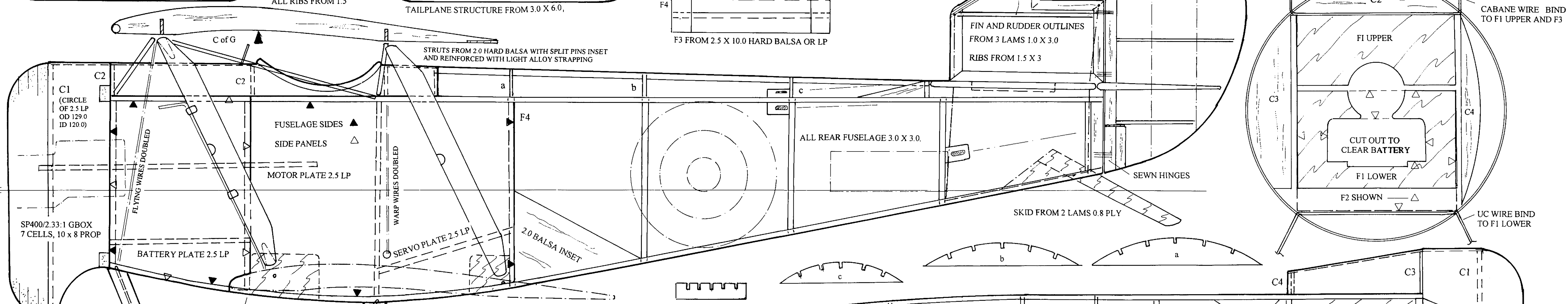
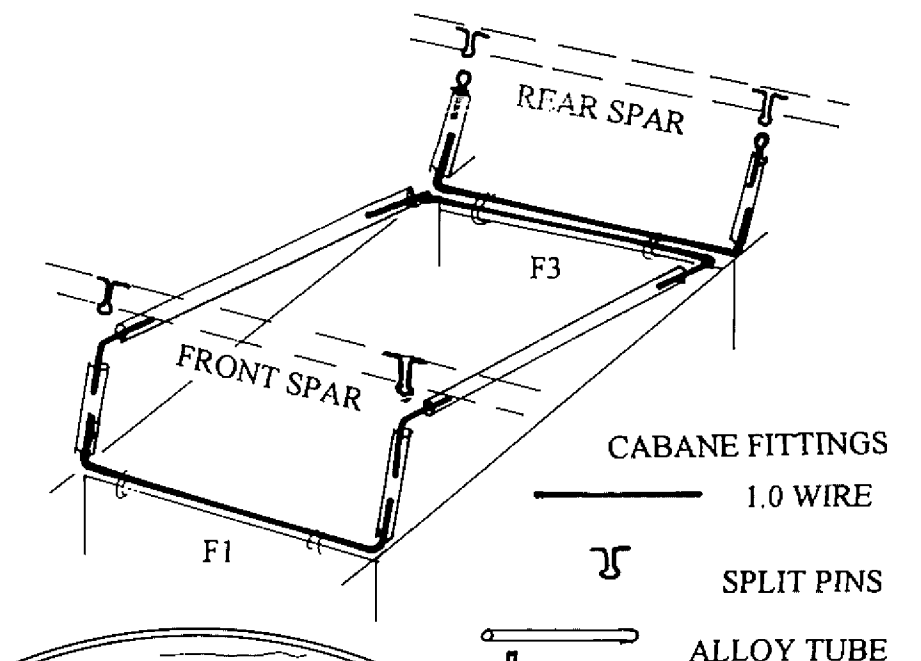
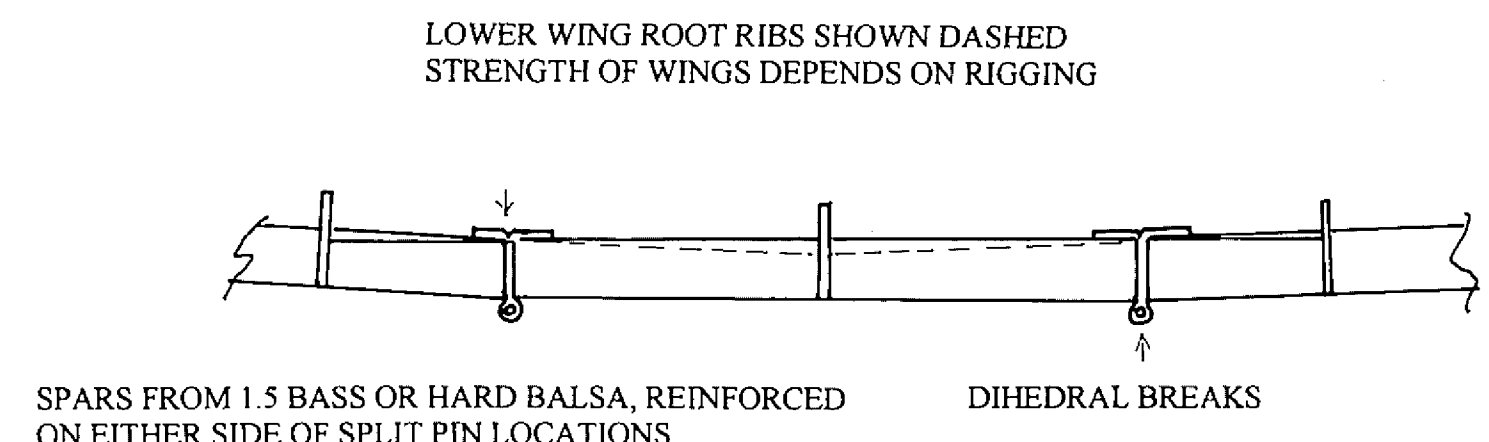
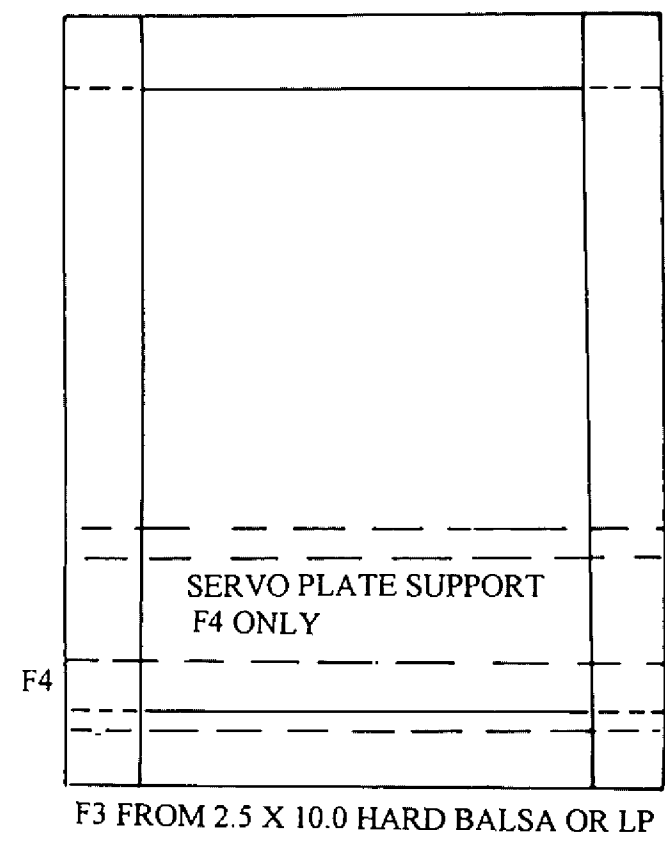
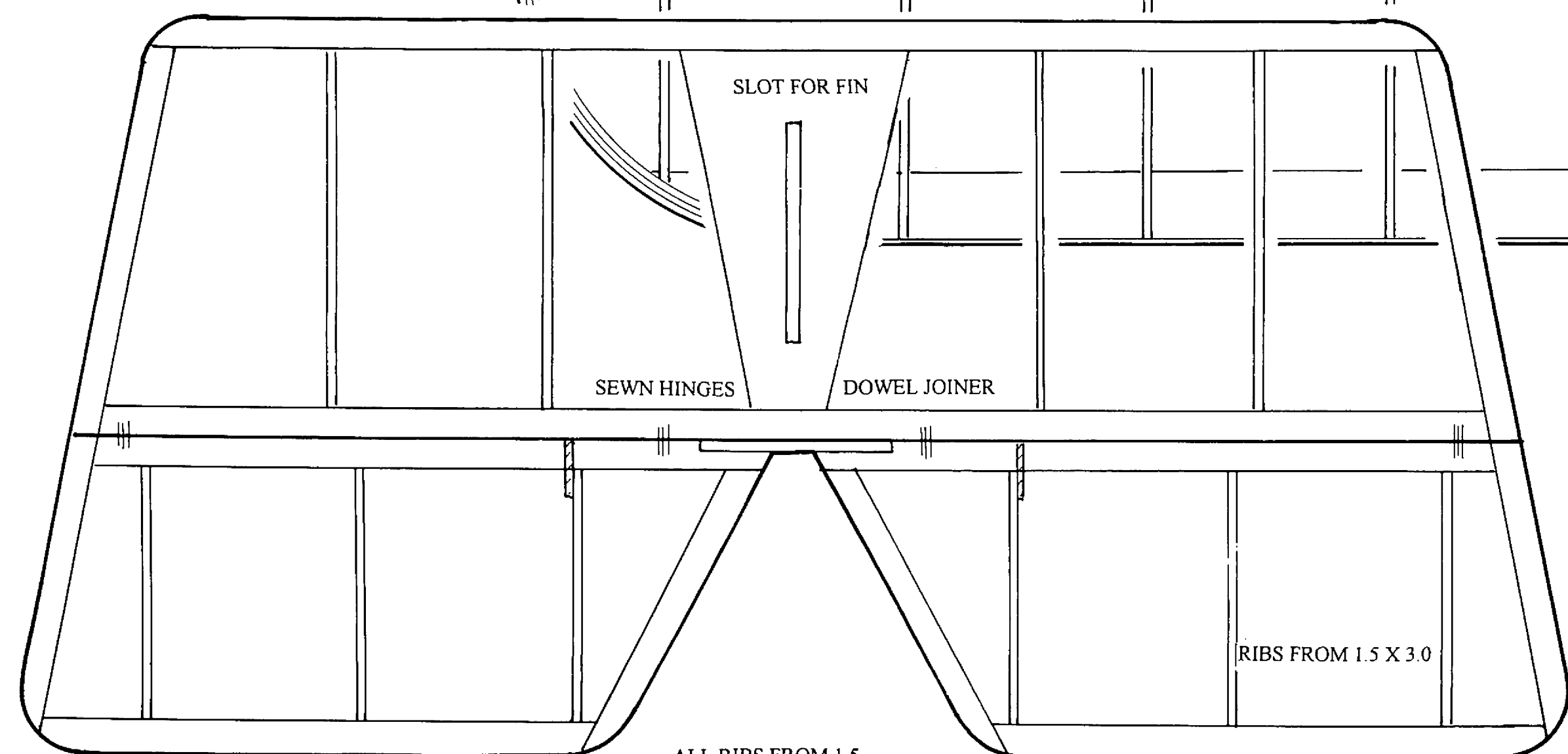
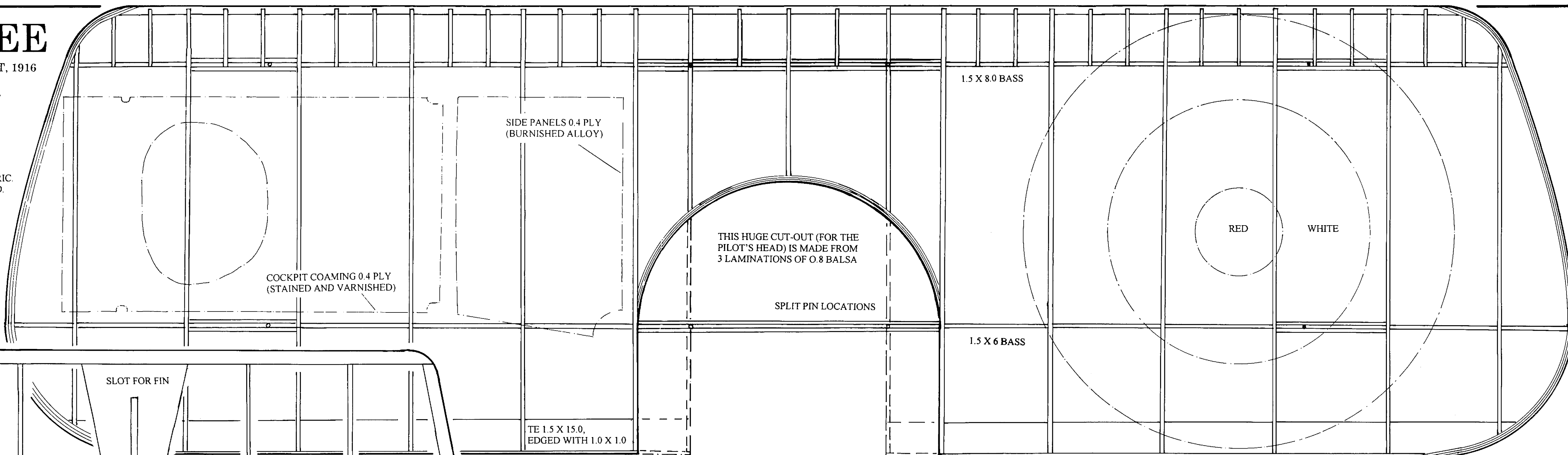

MAKE WHEELS FROM 6.0 SOFT Balsa SANDWICHED BETWEEN 0.8 PLY DISCS. EPOXY TUBE BEARING AND SPIN TRUE WHILE DRYING. RUBBER TYRE FROM PORTMERE 10.0 SPONGE RUBBER CORD. WHEEL COVER FROM CARD, CREAMED TO SIMULATE SPOKES

FAIR UC LEGS WITH CARD OR FLATTENED ALLOY TUBE

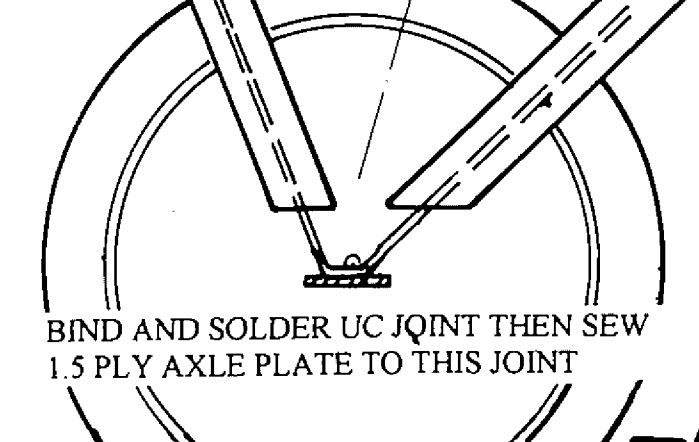

BIND AND SOLDER UC JOINT THEN SEW 1.5 PLY AXLE PLATE TO THIS JOINT

