

**Peter Rake's
Bristol Scout**
Copyright P. Rake 2015

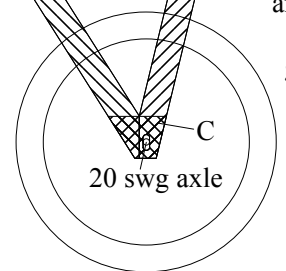

u/c shown full size assemble over drawing and glue assemblies into F3 & UC glue axle into slot

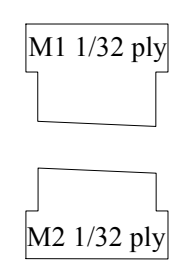
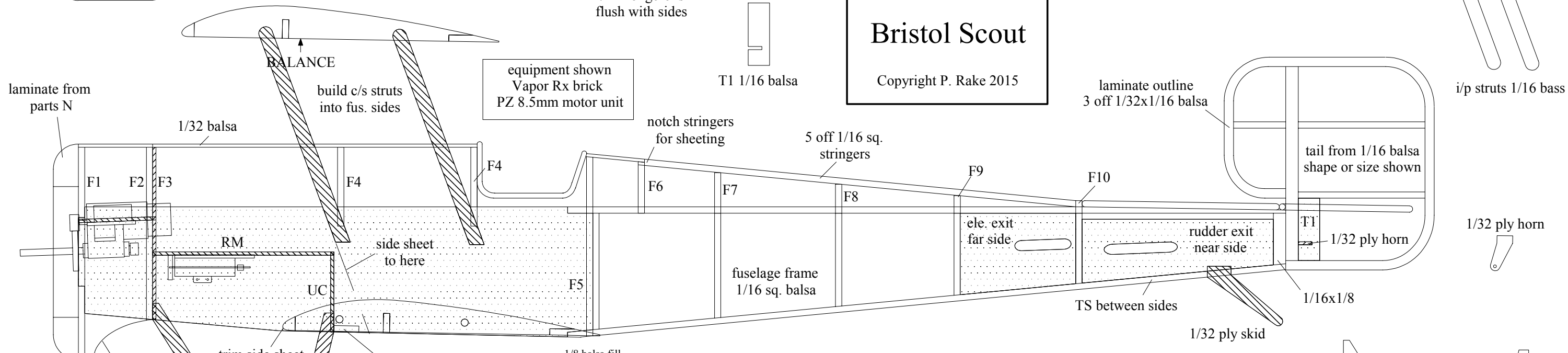
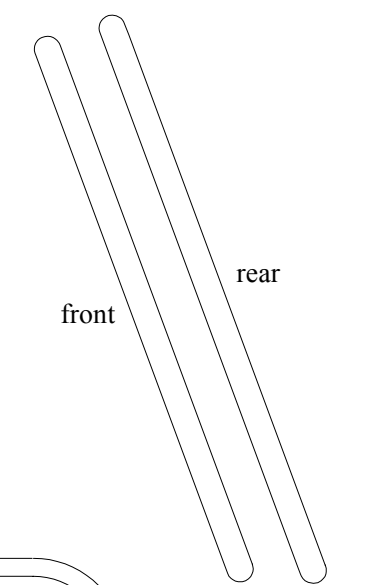
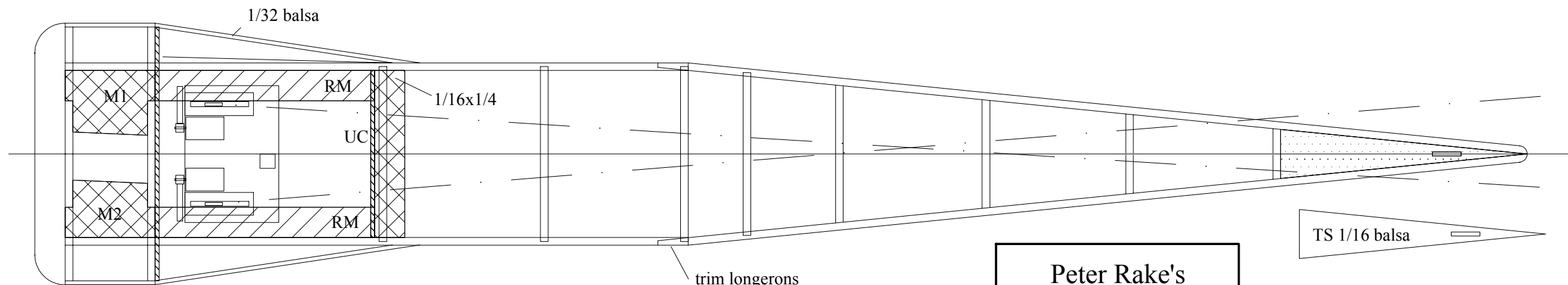
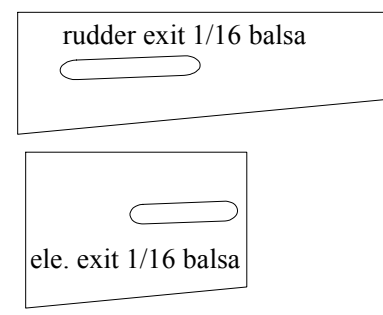
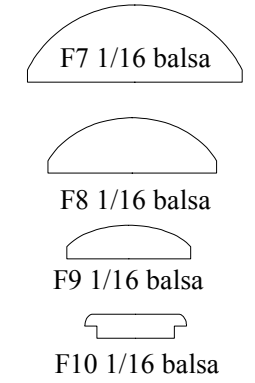
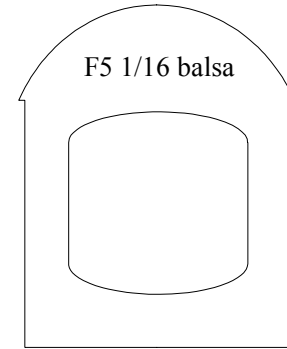
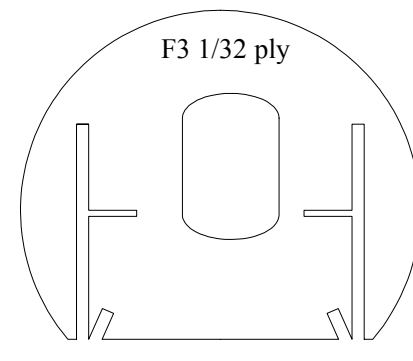
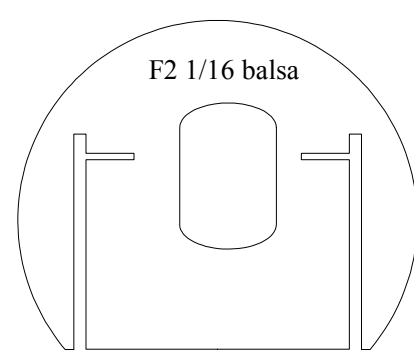
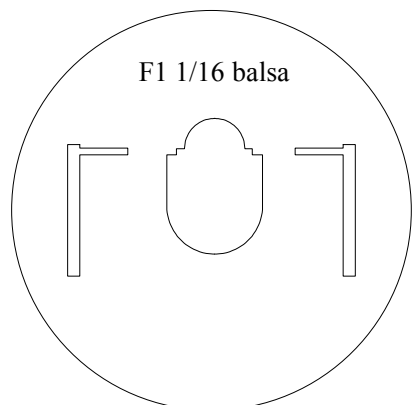
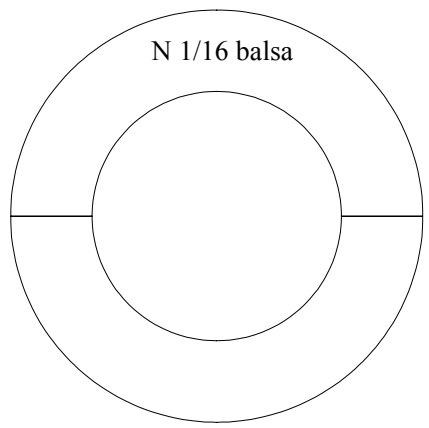
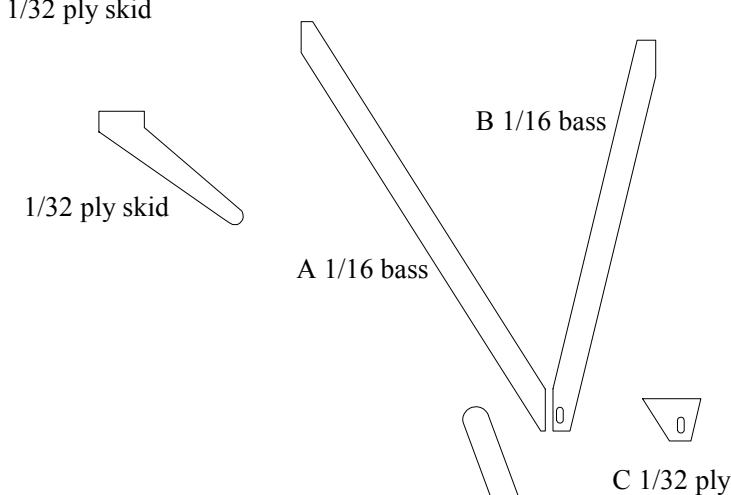
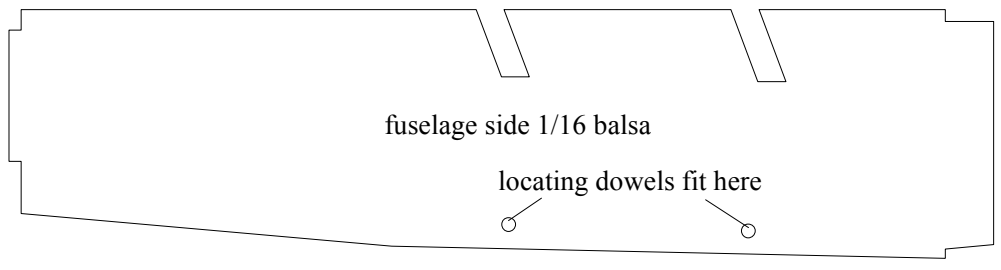
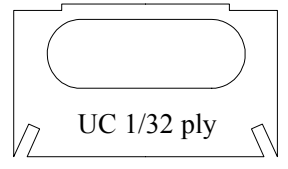

c/s strut 1/16 bass

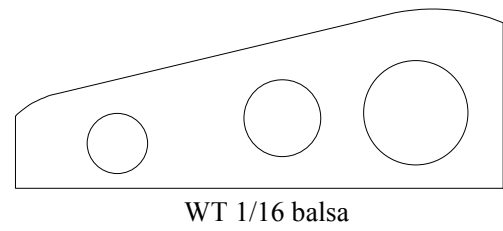
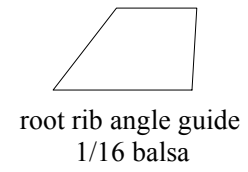

Peter Rake's
Bristol Scout
Copyright P. Rake 2015

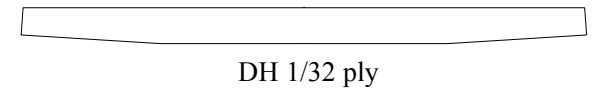

0.5" dihedral under tip
all wings

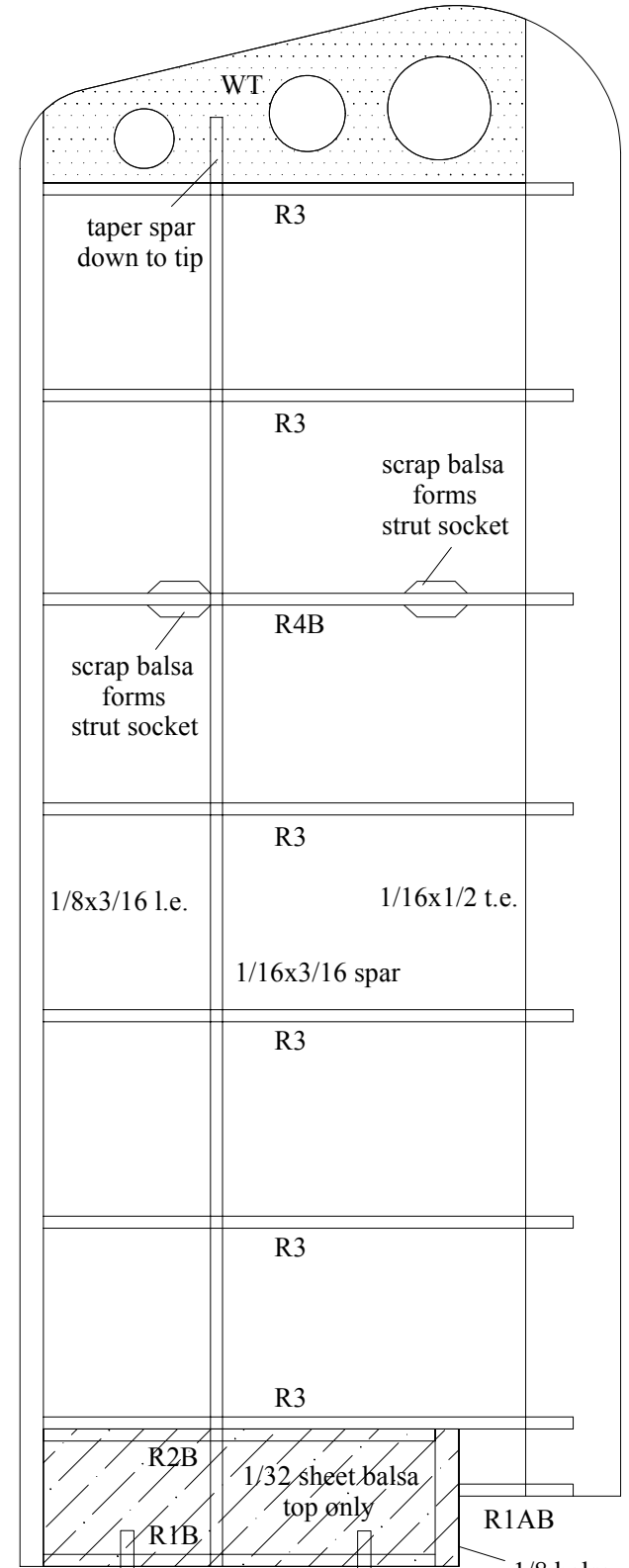
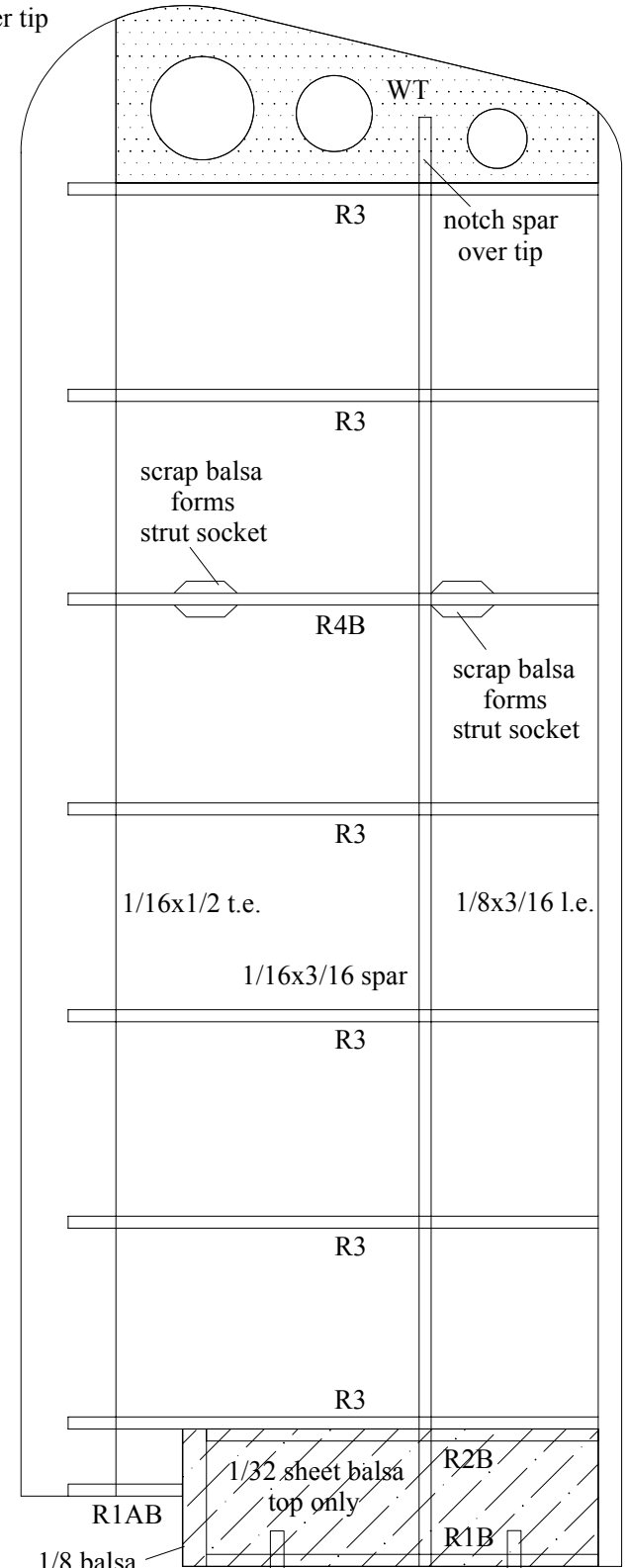
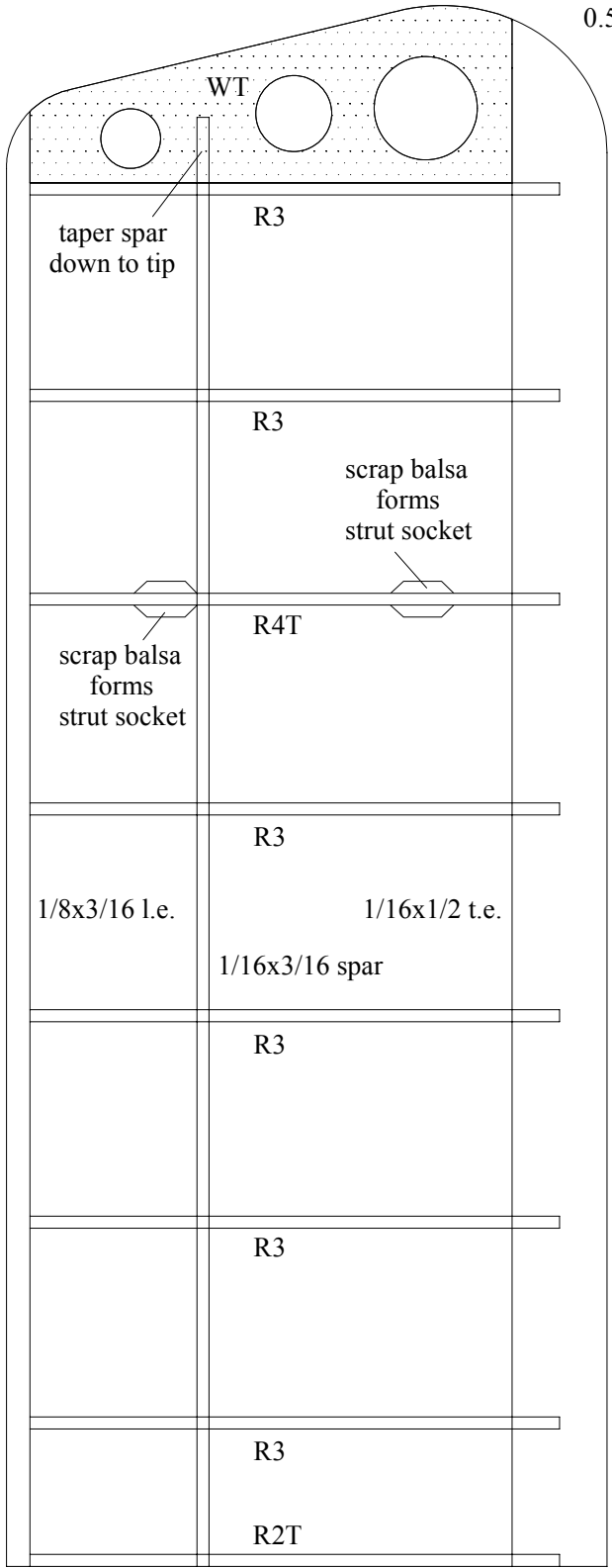
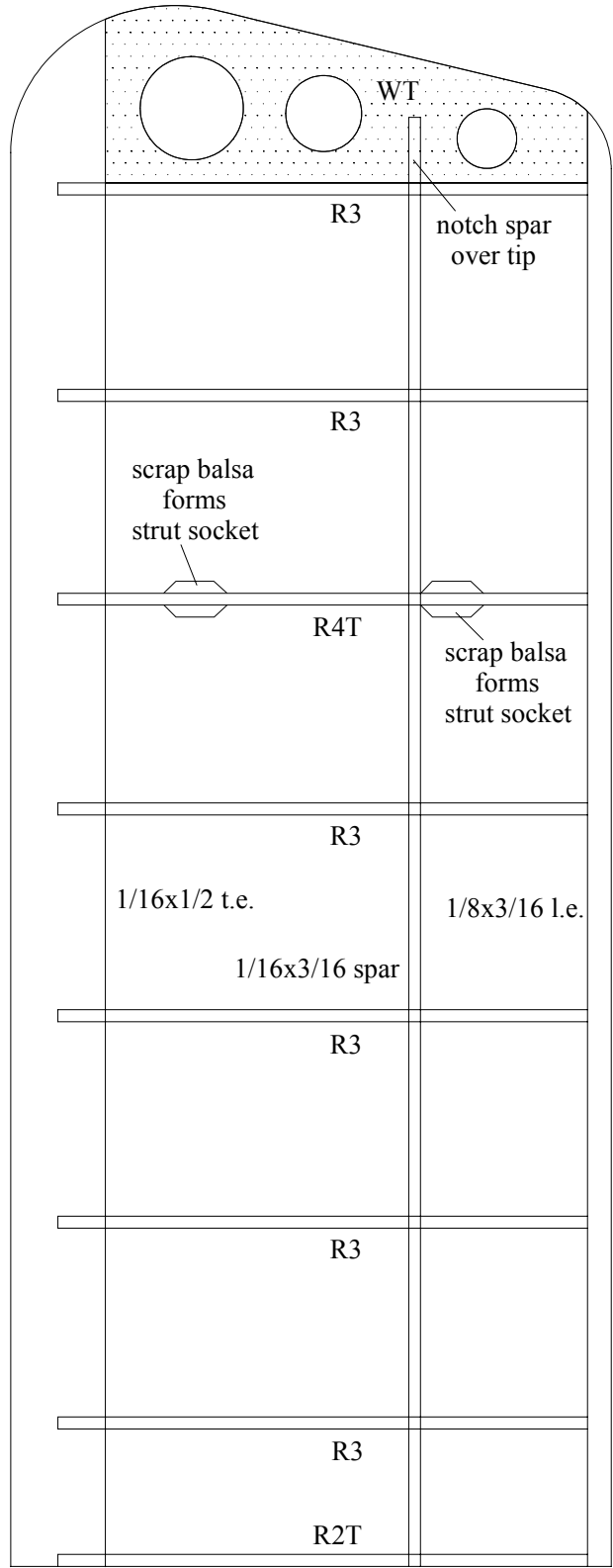

angle all root ribs for dihedral

c/tail stick
locating dowels

c/tail stick
locating dowels

Peter Rake's Bristol Scout

Copyright P. Rake 2015

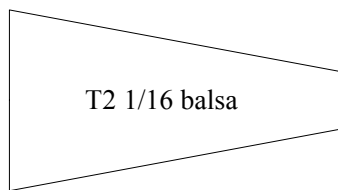
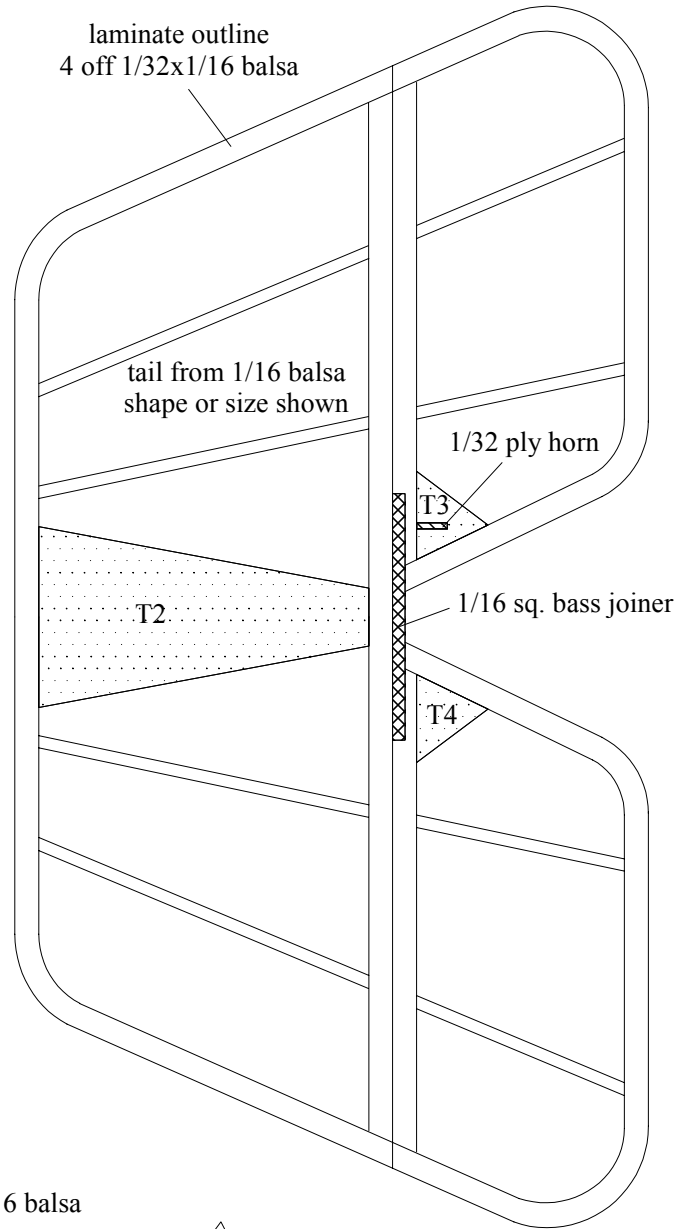
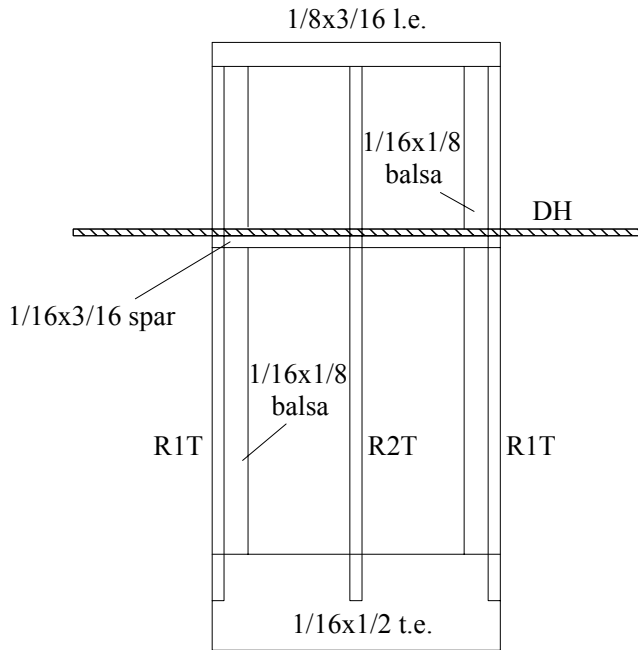

T3 1/16 balsa

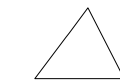

T4 1/16 balsa

top wing ribs

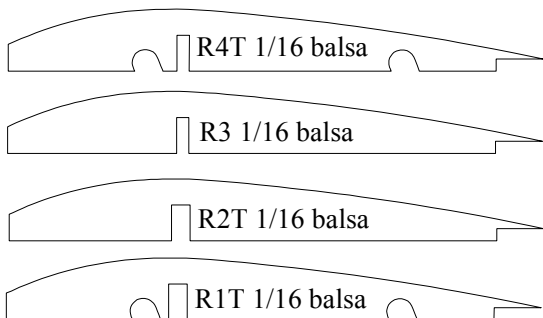

bottom wing ribs

