

Chicken Hawk

34/25" 1/2A BIPLANE FOR SINGLE CHANNEL R/C

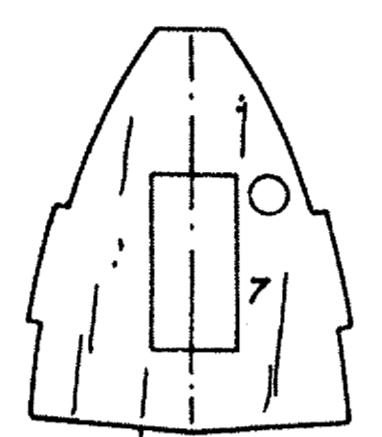

1/16" SHEET Balsa USED THROUGHOUT UNLESS NOTED

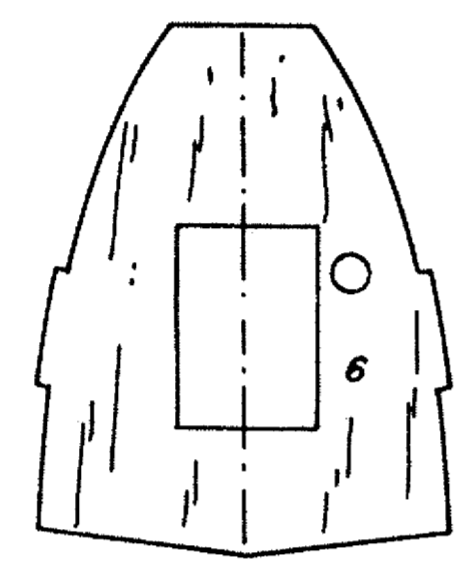
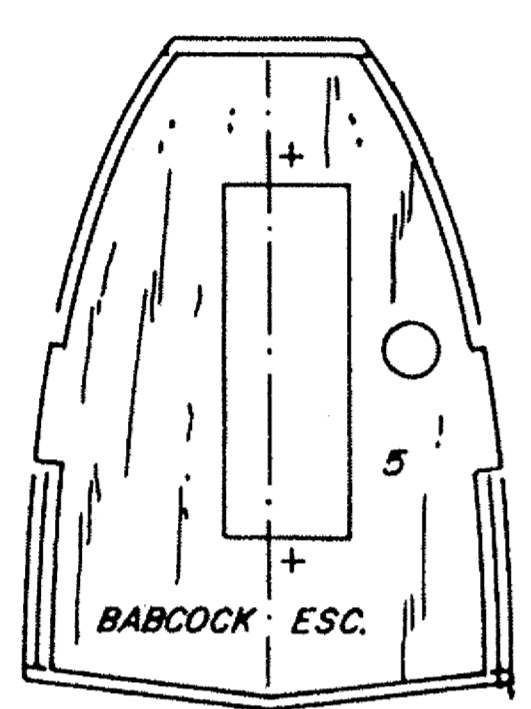
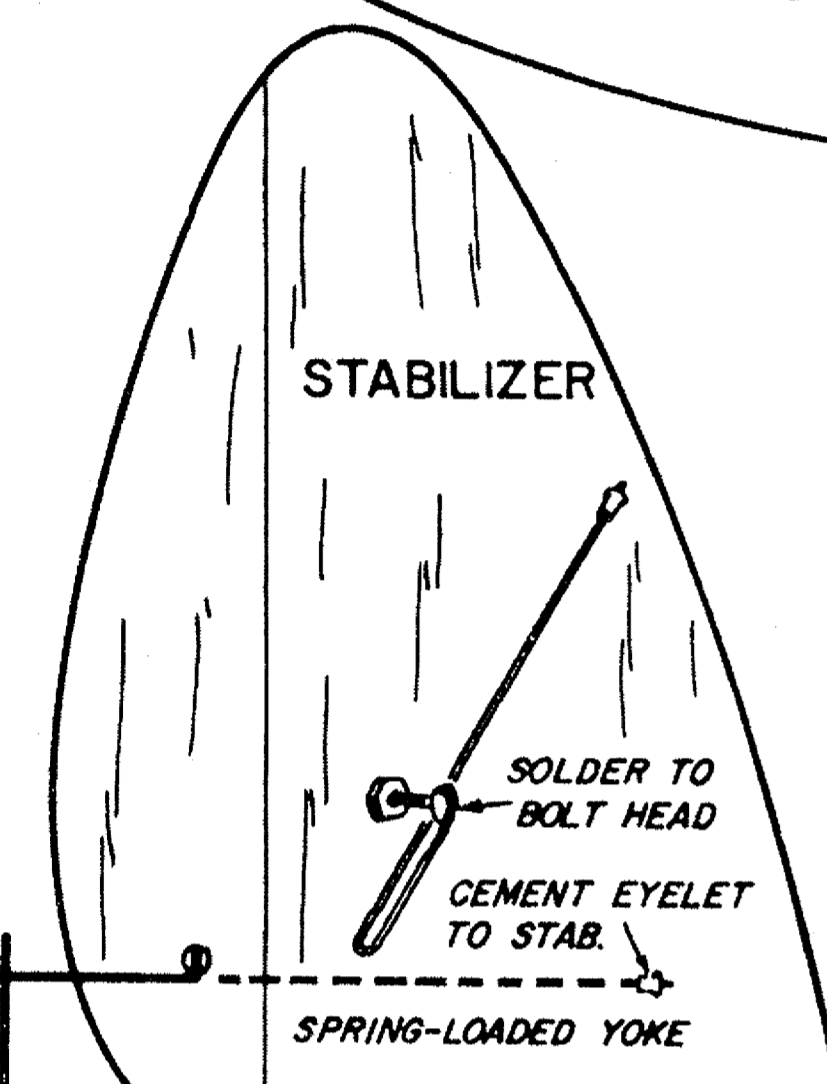
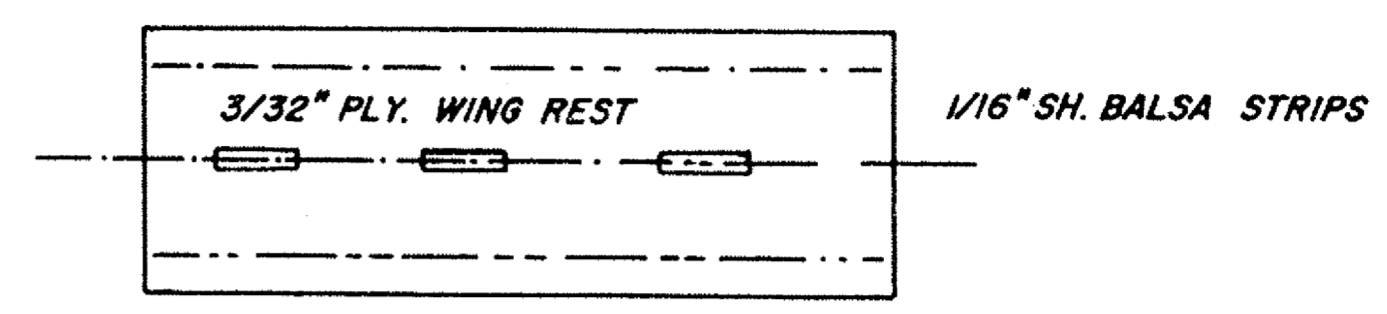
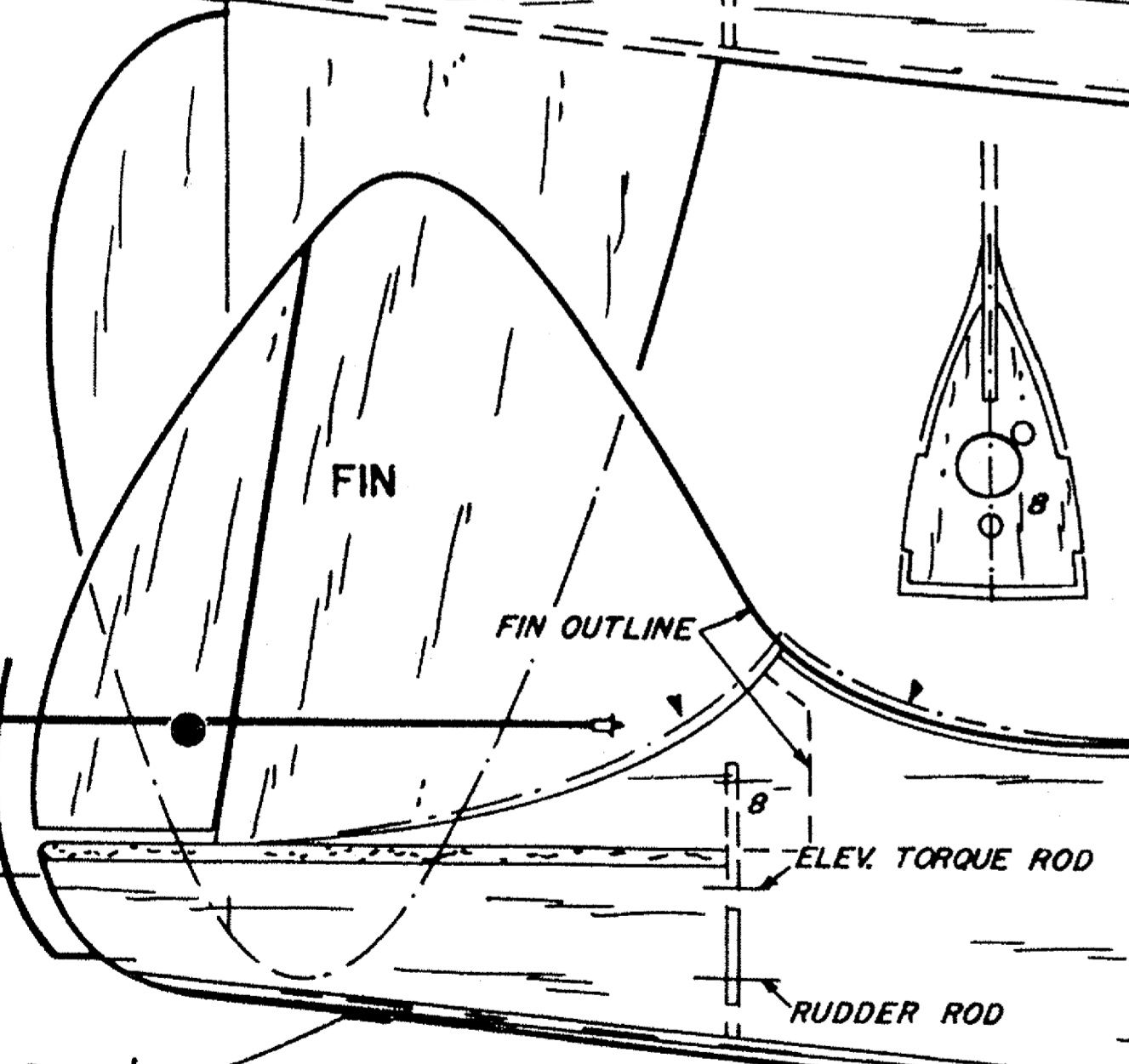
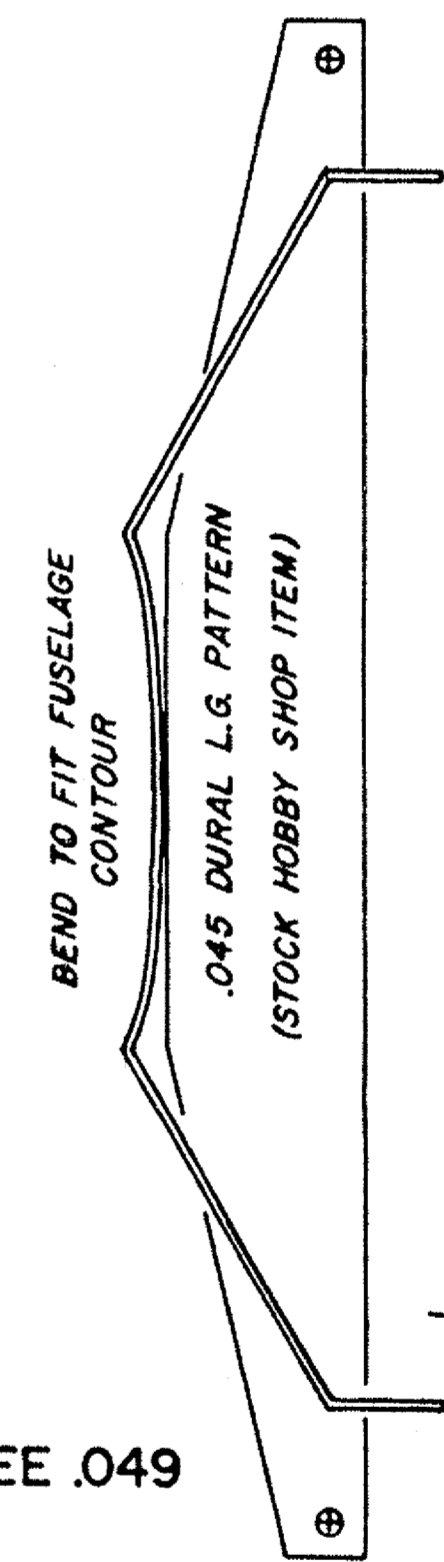
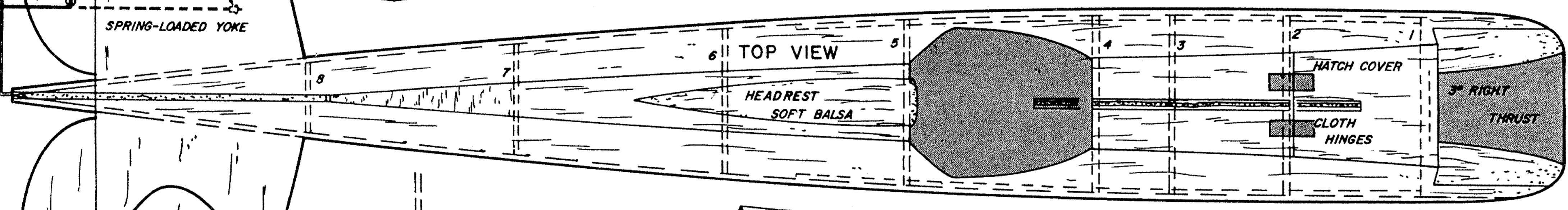
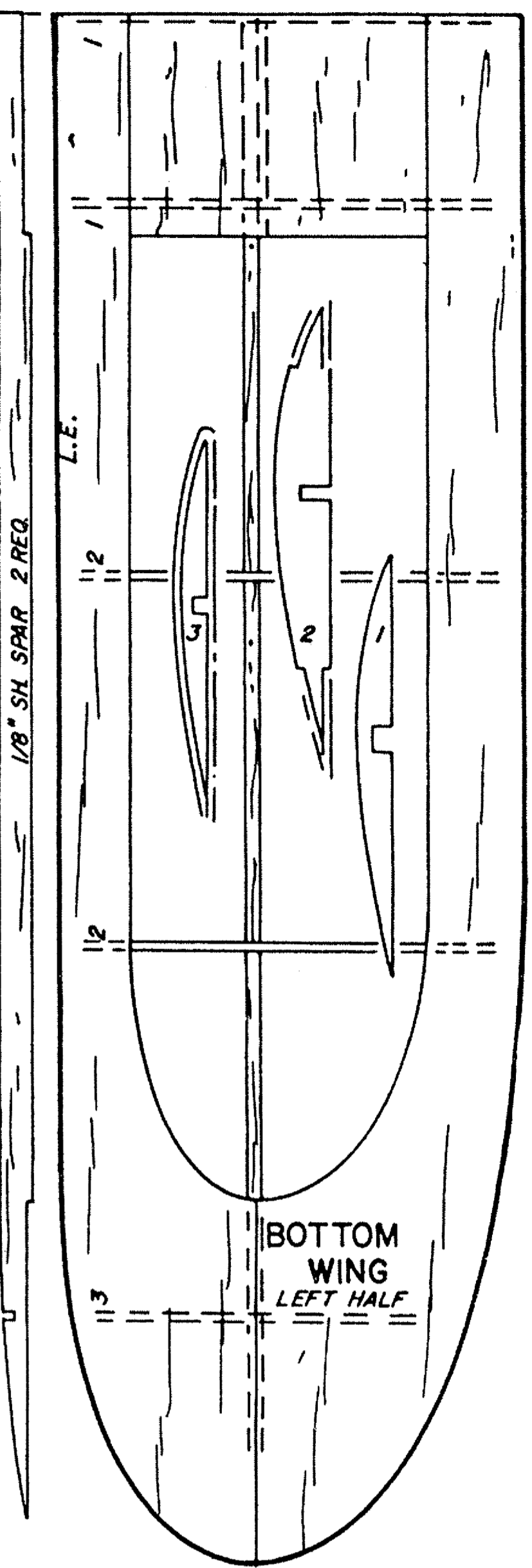
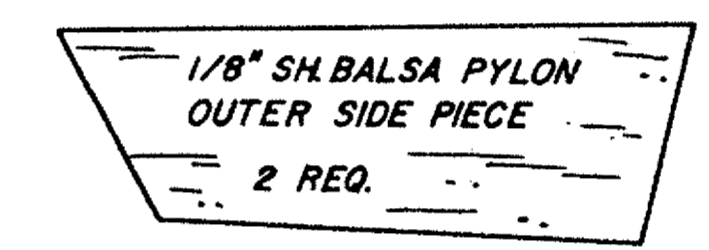
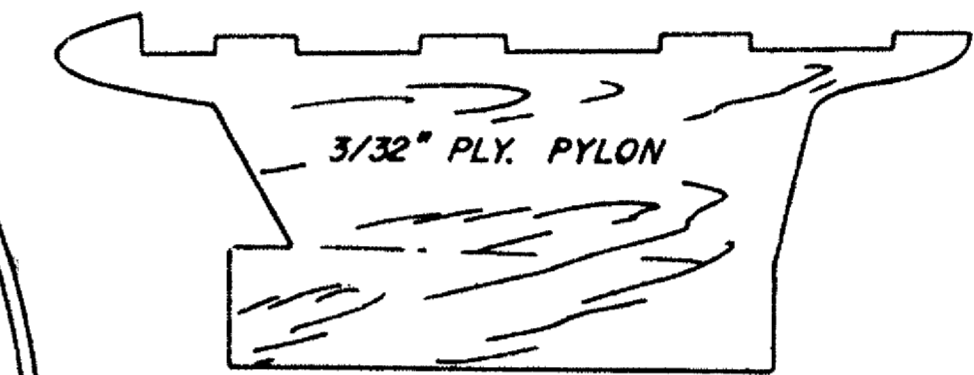
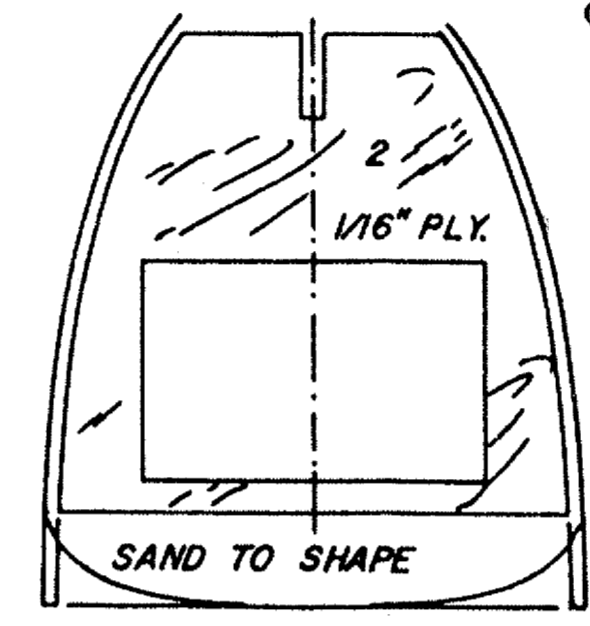

▼ DENOTES FUSELAGE SIDE OUTLINE PATTERN

TOP WING DIHEDRAL 1-1/2" EACH TIP

BOTTOM WING DIHEDRAL 1-1/8" EACH TIP

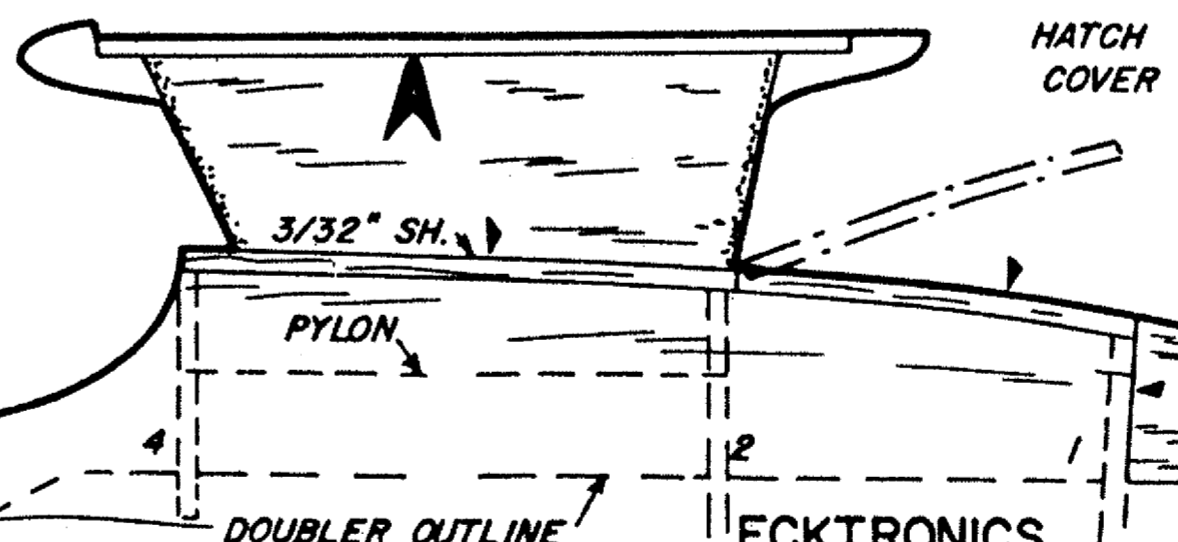
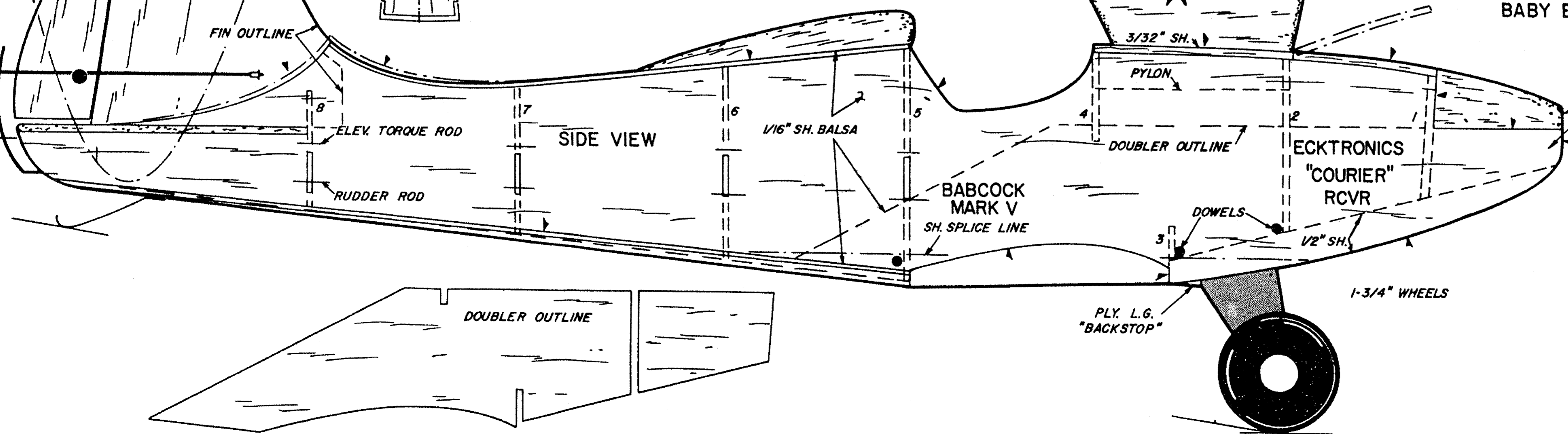

BABY BEE .049

FILL IN WITH 1/2" SH.

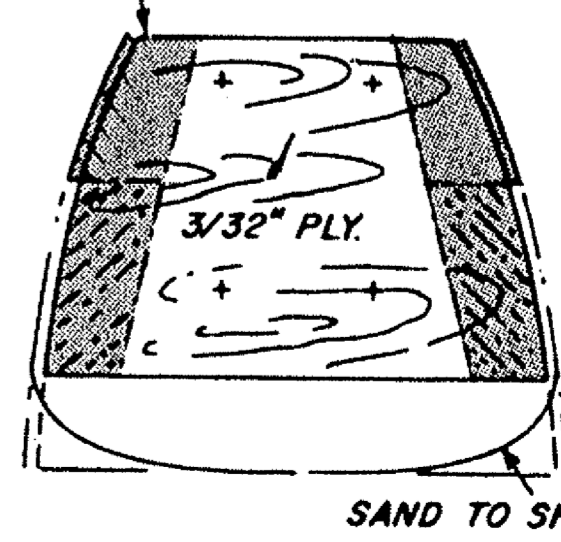

SAND TO SHAPE

3 1/16" PLY.

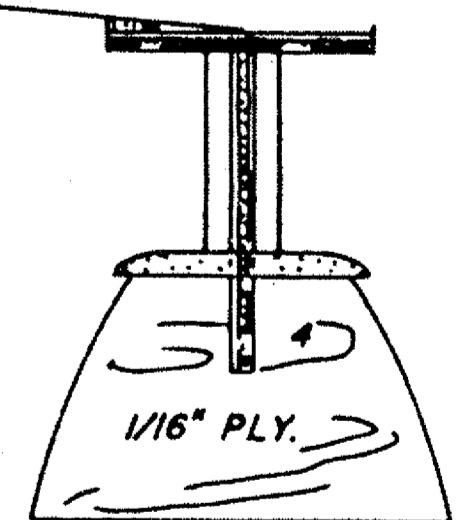

PLY. L.G. "BACKSTOP"

1-3/4" WHEELS

ECKTRONICS "COURIER" RCVR

BABCOCK MARK V SH. SPLICE LINE

1/16" SH. Balsa

SIDE VIEW

ELEV. TORQUE ROD

RUDDER ROD

DOUBLER OUTLINE

HATCH COVER

DOUBLER OUTLINE

DOWELS

1/2" SH.

PLY. L.G. "BACKSTOP"

1-3/4" WHEELS

ECKTRONICS "COURIER" RCVR

BABCOCK MARK V SH. SPLICE LINE

1/16" SH. Balsa

SIDE VIEW

ELEV. TORQUE ROD

RUDDER ROD

DOUBLER OUTLINE

HATCH COVER

DOUBLER OUTLINE

DOWELS

1/2" SH.

PLY. L.G. "BACKSTOP"

1-3/4" WHEELS

ECKTRONICS "COURIER" RCVR

BABCOCK MARK V SH. SPLICE LINE

1/16" SH. Balsa

SIDE VIEW

ELEV. TORQUE ROD

RUDDER ROD

DOUBLER OUTLINE

HATCH COVER

DOUBLER OUTLINE

DOWELS

1/2" SH.

PLY. L.G. "BACKSTOP"

1-3/4" WHEELS

ECKTRONICS "COURIER" RCVR

BABCOCK MARK V SH. SPLICE LINE

1/16" SH. Balsa

SIDE VIEW

ELEV. TORQUE ROD

RUDDER ROD

DOUBLER OUTLINE

HATCH COVER

DOUBLER OUTLINE

DOWELS

1/2" SH.

PLY. L.G. "BACKSTOP"

1-3/4" WHEELS

ECKTRONICS "COURIER" RCVR

BABCOCK MARK V SH. SPLICE LINE

1/16" SH. Balsa

SIDE VIEW

ELEV. TORQUE ROD

RUDDER ROD

DOUBLER OUTLINE

HATCH COVER

DOUBLER OUTLINE

DOWELS

1/2" SH.

PLY. L.G. "BACKSTOP"

1-3/4" WHEELS

ECKTRONICS "COURIER" RCVR

BABCOCK MARK V SH. SPLICE LINE

1/16" SH. Balsa

SIDE VIEW

ELEV. TORQUE ROD

RUDDER ROD

DOUBLER OUTLINE

HATCH COVER

DOUBLER OUTLINE

DOWELS

1/2" SH.

PLY. L.G. "BACKSTOP"

1-3/4" WHEELS

ECKTRONICS "COURIER" RCVR

BABCOCK MARK V SH. SPLICE LINE

1/16" SH. Balsa

SIDE VIEW

ELEV. TORQUE ROD

RUDDER ROD

DOUBLER OUTLINE

HATCH COVER

DOUBLER OUTLINE

DOWELS

1/2" SH.

PLY. L.G. "BACKSTOP"

1-3/4" WHEELS

ECKTRONICS "COURIER" RCVR

BABCOCK MARK V SH. SPLICE LINE

1/16" SH. Balsa

SIDE VIEW

ELEV. TORQUE ROD

RUDDER ROD

DOUBLER OUTLINE

HATCH COVER

DOUBLER OUTLINE

DOWELS

1/2" SH.

PLY. L.G. "BACKSTOP"

1-3/4" WHEELS

ECKTRONICS "COURIER" RCVR

BABCOCK MARK V SH. SPLICE LINE

1/16" SH. Balsa

SIDE VIEW

ELEV. TORQUE ROD

RUDDER ROD

DOUBLER OUTLINE

HATCH COVER

DOUBLER OUTLINE

DOWELS

1/2" SH.

PLY. L.G. "BACKSTOP"

1-3/4" WHEELS

ECKTRONICS "COURIER" RCVR

BABCOCK MARK V SH. SPLICE LINE

1/16" SH. Balsa

SIDE VIEW

ELEV. TORQUE ROD

RUDDER ROD

DOUBLER OUTLINE

HATCH COVER

DOUBLER OUTLINE

DOWELS

1/2" SH.

PLY. L.G. "BACKSTOP"

1-3/4" WHEELS

ECKTRONICS "COURIER" RCVR

BABCOCK MARK V SH. SPLICE LINE

1/16" SH. Balsa

SIDE VIEW

ELEV. TORQUE ROD

RUDDER ROD

DOUBLER OUTLINE

HATCH COVER

DOUBLER OUTLINE

DOWELS

1/2" SH.

PLY. L.G. "BACKSTOP"

1-3/4" WHEELS

ECKTRONICS "COURIER" RCVR

BABCOCK MARK V SH. SPLICE LINE

1/16" SH. Balsa

SIDE VIEW

ELEV. TORQUE ROD

RUDDER ROD

DOUBLER OUTLINE

HATCH COVER

DOUBLER OUTLINE

DOWELS

1/2" SH.

PLY. L.G. "BACKSTOP"

1-3/4" WHEELS

ECKTRONICS "COURIER" RCVR

BABCOCK MARK V SH. SPLICE LINE

1/16" SH. Balsa

SIDE VIEW

ELEV. TORQUE ROD

RUDDER ROD

DOUBLER OUTLINE

HATCH COVER

DOUBLER OUTLINE

DOWELS

1/2" SH.

PLY. L.G. "BACKSTOP"

1-3/4" WHEELS

ECKTRONICS "COURIER" RCVR

BABCOCK MARK V SH. SPLICE LINE

1/16" SH. Balsa

SIDE VIEW

ELEV. TORQUE ROD

RUDDER ROD

DOUBLER OUTLINE

HATCH COVER

DOUBLER OUTLINE

DOWELS

1/2" SH.

PLY. L.G. "BACKSTOP"

1-3/4" WHEELS

ECKTRONICS "COURIER" RCVR

BABCOCK MARK V SH. SPLICE LINE

1/16" SH. Balsa

SIDE VIEW

ELEV. TORQUE ROD

RUDDER ROD

DOUBLER OUTLINE

HATCH COVER

DOUBLER OUTLINE

DOWELS

1/2" SH.

PLY. L.G. "BACKSTOP"

1-3/4" WHEELS

ECKTRONICS "COURIER" RCVR

BABCOCK MARK V SH. SPLICE LINE

1/16" SH. Balsa

SIDE VIEW

ELEV. TORQUE ROD

RUDDER ROD

DOUBLER OUTLINE

HATCH COVER

DOUBLER OUTLINE

DOWELS

1/2" SH.

PLY. L.G. "BACKSTOP"

1-3/4" WHEELS

ECKTRONICS "COURIER" RCVR

BABCOCK MARK V SH. SPLICE LINE

1/16" SH. Balsa

SIDE VIEW

ELEV. TORQUE ROD

RUDDER ROD

DOUBLER OUTLINE

HATCH COVER

DOUBLER OUTLINE

DOWELS

1/2" SH.

PLY. L.G. "BACKSTOP"

1-3/4" WHEELS

ECKTRONICS "COURIER" RCVR

BABCOCK MARK V SH. SPLICE LINE

1/16" SH. Balsa

SIDE VIEW

ELEV. TORQUE ROD

RUDDER ROD

DOUBLER OUTLINE

HATCH COVER

DOUBLER OUTLINE

DOWELS

1/2" SH.

PLY. L.G. "BACKSTOP"

1-3/4" WHEELS

ECKTRONICS "COURIER" RCVR

BABCOCK MARK V SH. SPLICE LINE

1/16" SH. Balsa

SIDE VIEW

ELEV. TORQUE ROD

RUDDER ROD

DOUBLER OUTLINE

HATCH COVER

DOUBLER OUTLINE

DOWELS

1/2" SH.

PLY. L.G. "BACKSTOP"

1-3/4" WHEELS

ECKTRONICS "COURIER" RCVR

BABCOCK MARK V SH. SPLICE LINE

1/16" SH. Balsa

SIDE VIEW

ELEV. TORQUE ROD

RUDDER ROD