

Carbonator I

Plate Two

Carbonator I

Plate Two (ctd.)

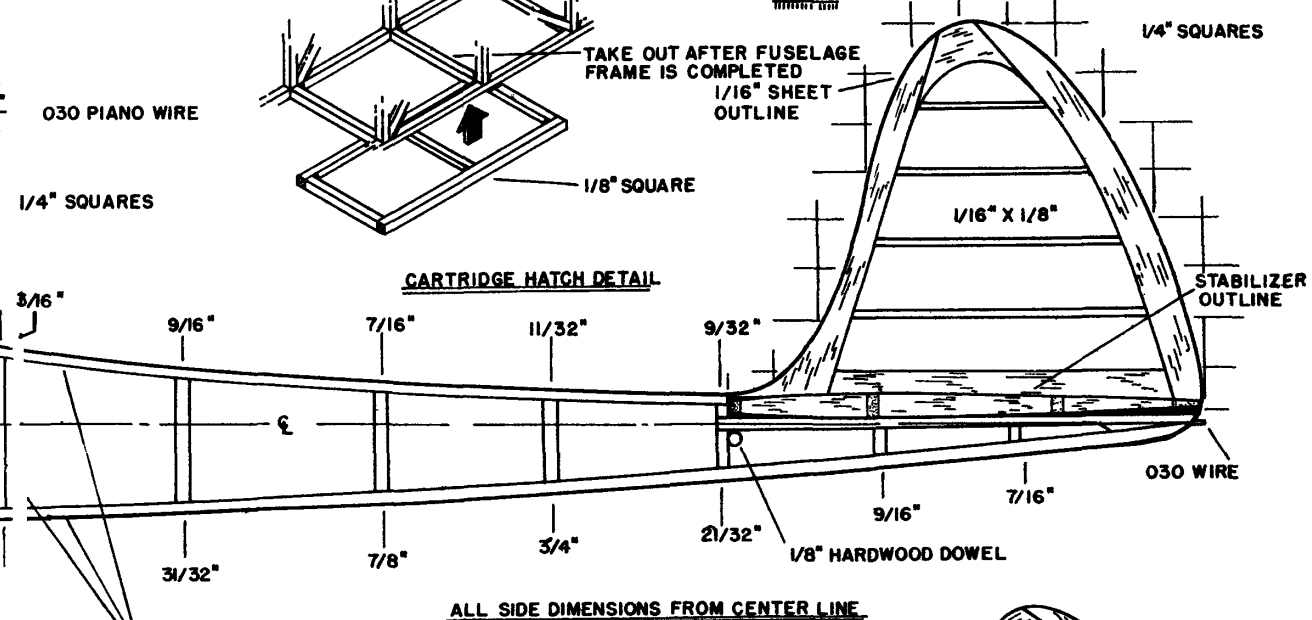
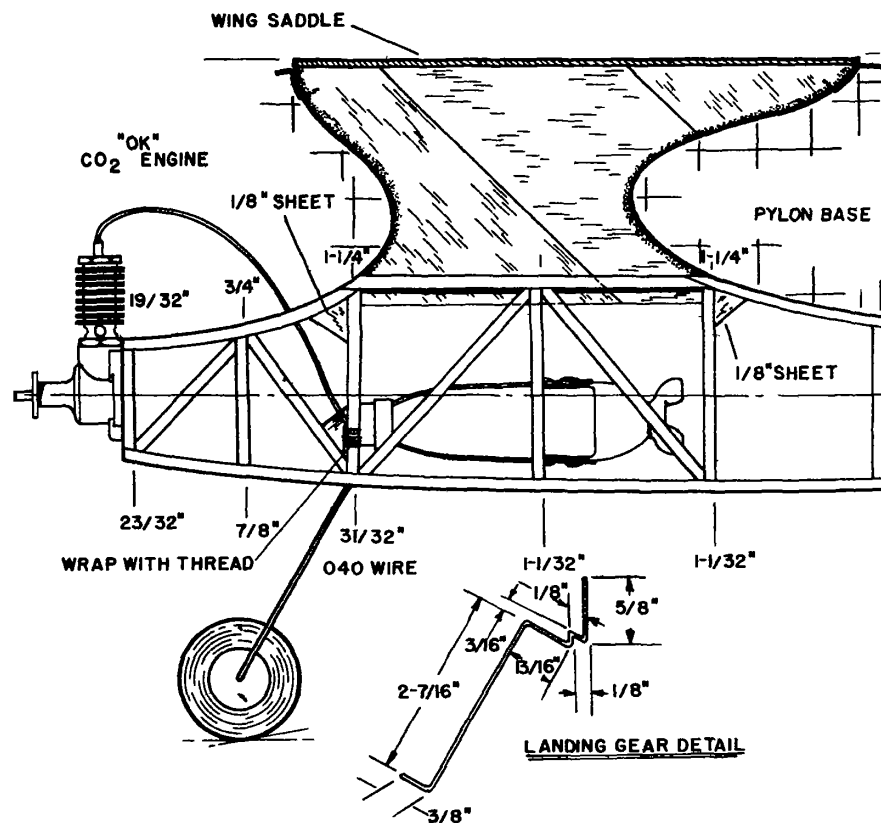
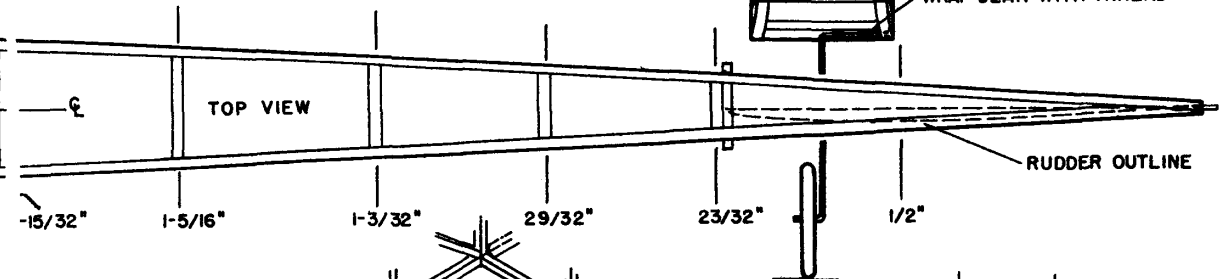
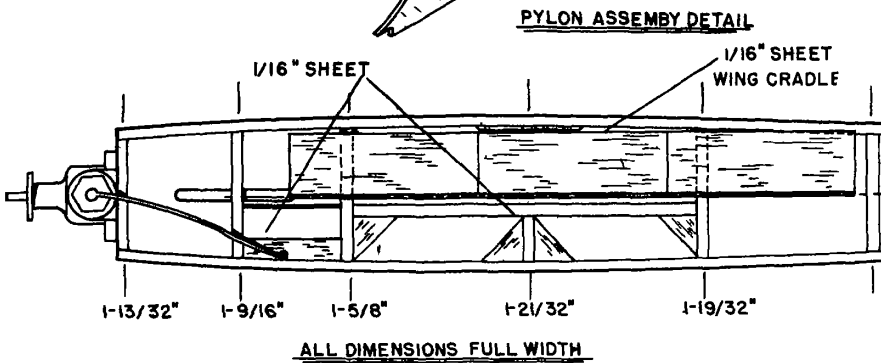
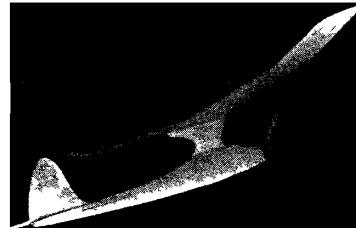
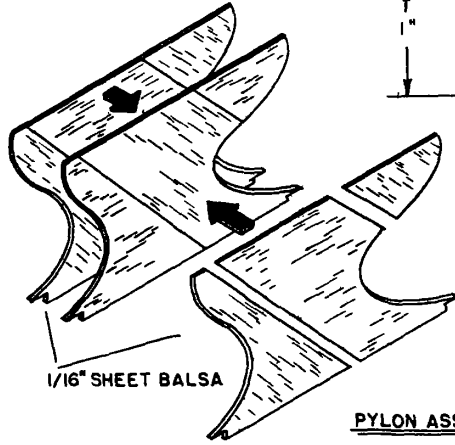
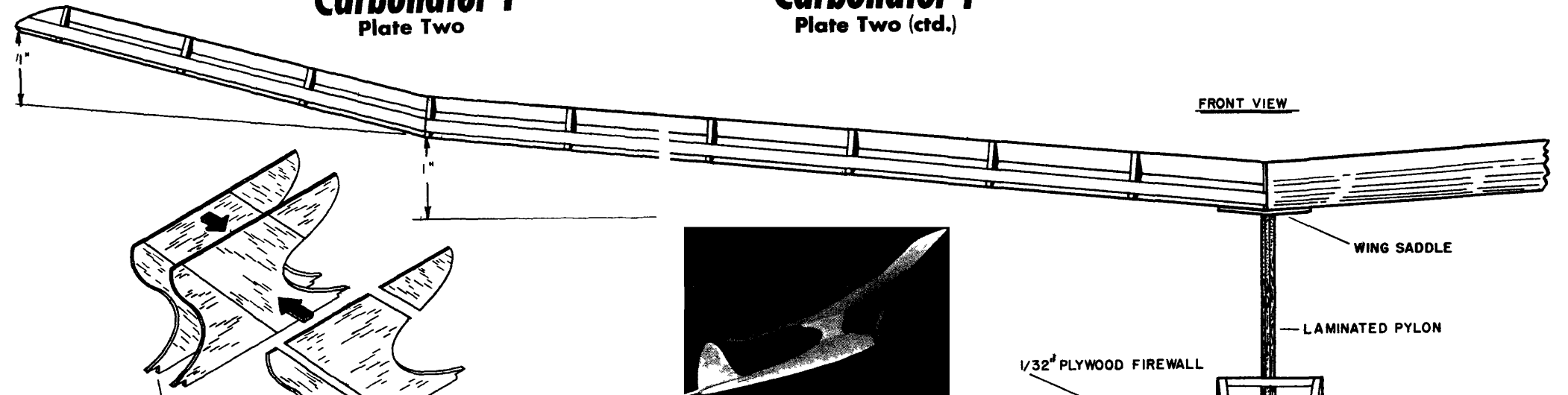

SCALE = HALF SIZE

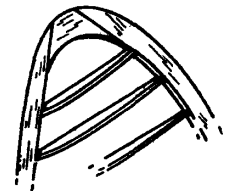

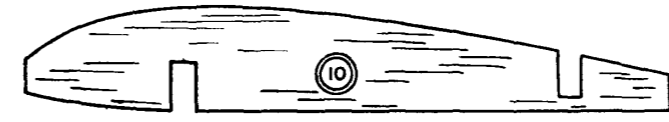
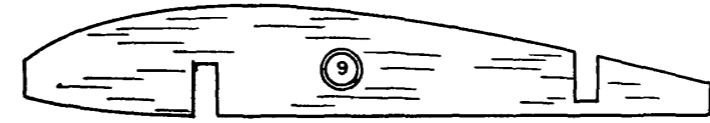
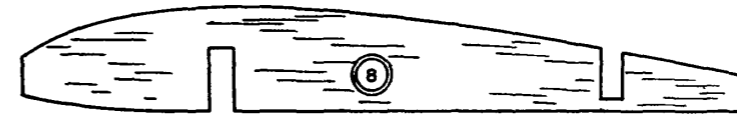
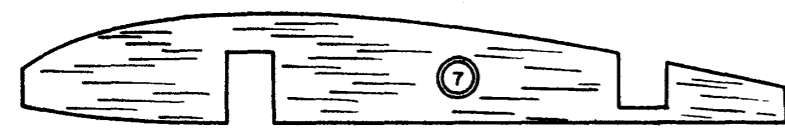
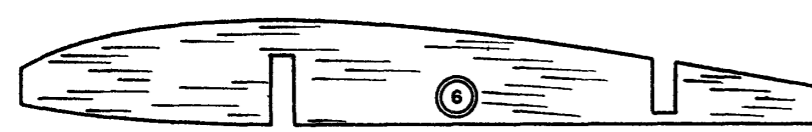
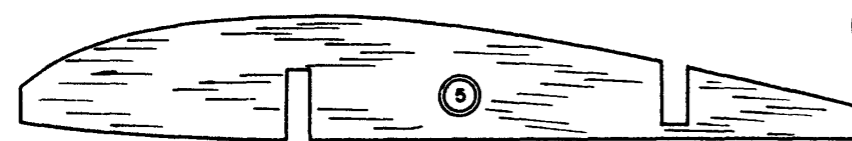
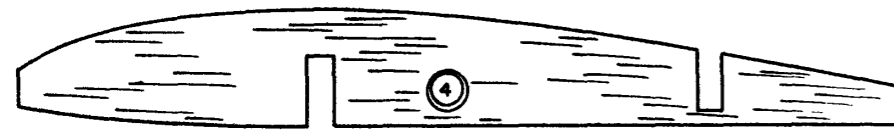
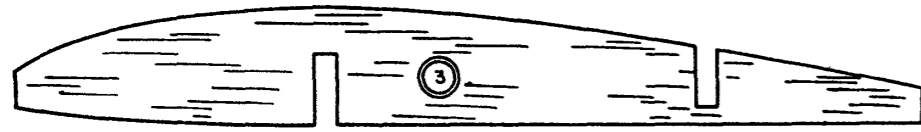
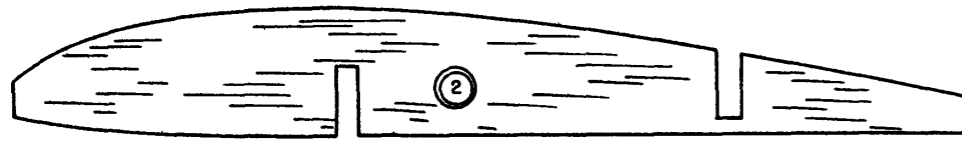
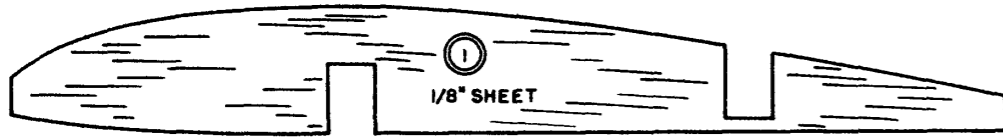
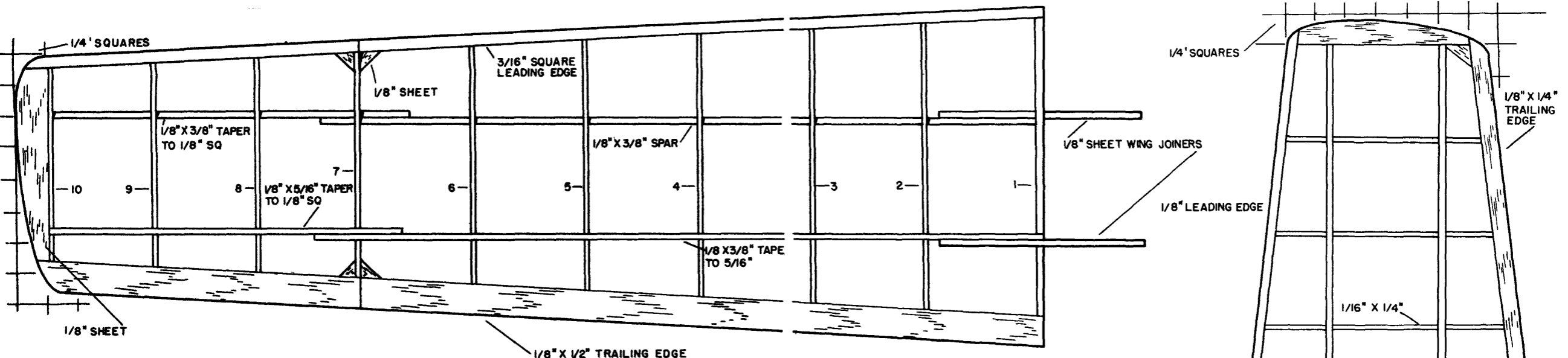

LL RIBS 1/16" SHEET EXCEPT AS INDICATED

Carbonator I
Plate Three (ctd.)

RIBS FULL SIZE

Carbonator I
Plate Three

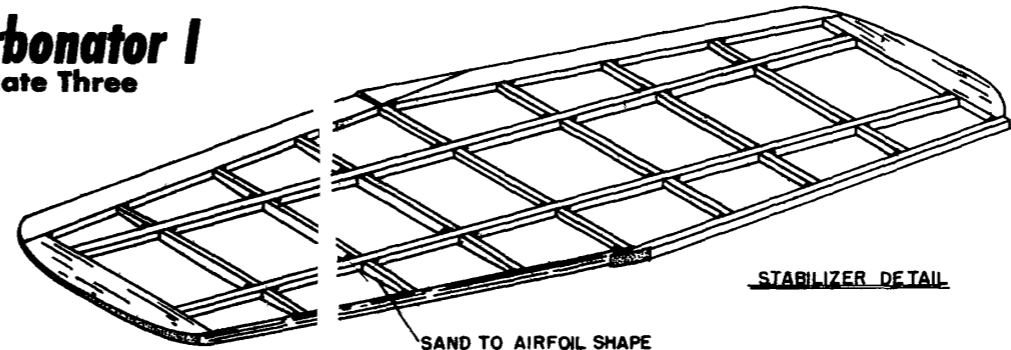

STABILIZER DETAIL

SAND TO AIRFOIL SHAPE

SCALE - HALF SIZE EXCEPT AS INDICATED

