

NOTE: SCALE DETAILS OMITTED ON THIS SHEET TO AVOID CONGESTION.
SEE THREE-VIEW OF FULL-SCALE SHIP.

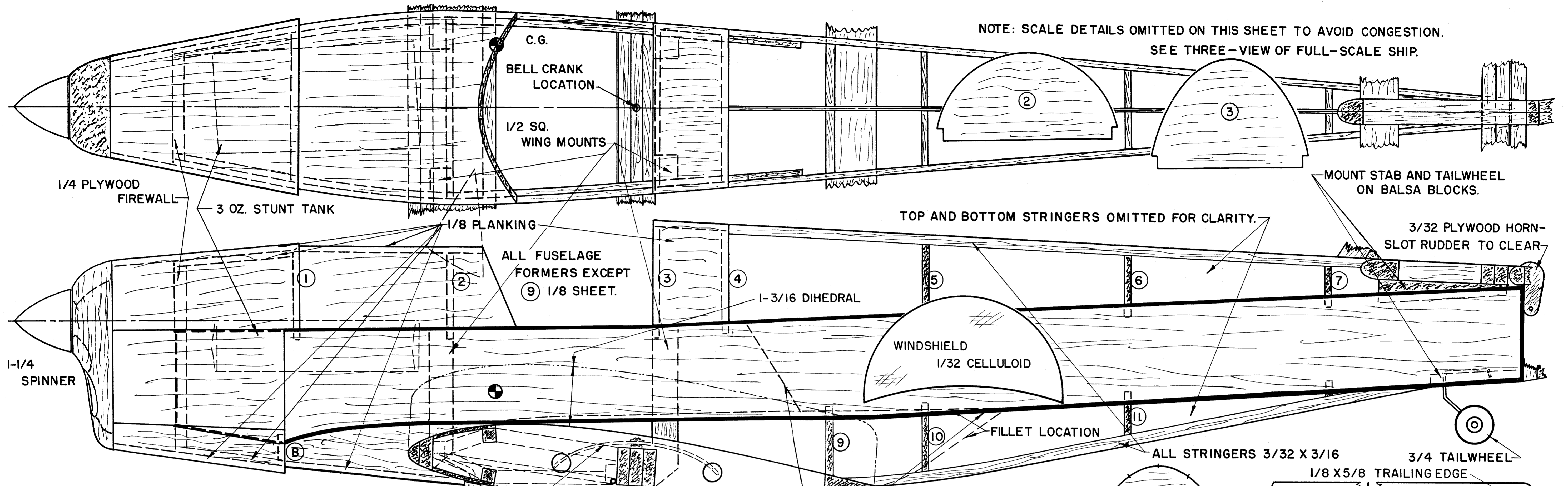

MOUNT STAB AND TAILWHEEL ON BALSA BLOCKS.

3/32 PLYWOOD HORN-SLOT RUDDER TO CLEAR

TOP AND BOTTOM STRINGERS OMITTED FOR CLARITY.

ALL FUSELAGE FORMERS EXCEPT 9 1/8 SHEET.

1-3/16 DIHEDRAL

WINDSHIELD 1/32 CELLULOID

FILLET LOCATION

ALL STRINGERS 3/32 X 3/16

3/4 TAILWHEEL

1/8 X 5/8 TRAILING EDGE

FOX 29 OR 35 MOUNTED FLUSH AGAINST FIREWALL, INVERTED, WITH METAL MOUNTS. COWLS IN COMPLETELY WITH SHORT PLUG. HINGE BOTTOM OF COWL FOR ACCESS.

NOTE BENT 3-INCH BELL CRANK SIDES DOUBLE THICKNESS AHEAD OF DOTTED LINE.

1/8 SHEET SIDES DENOTED STRINGER LOCATIONS

TIPSY

2-1/4 WHEELS

5/16 X 1 TRAILING EDGE

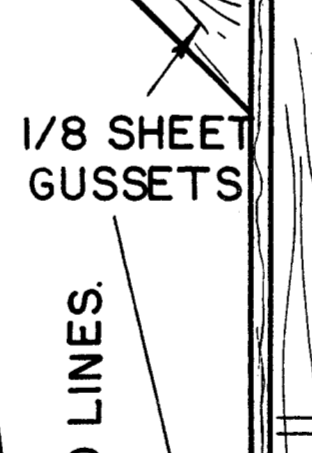
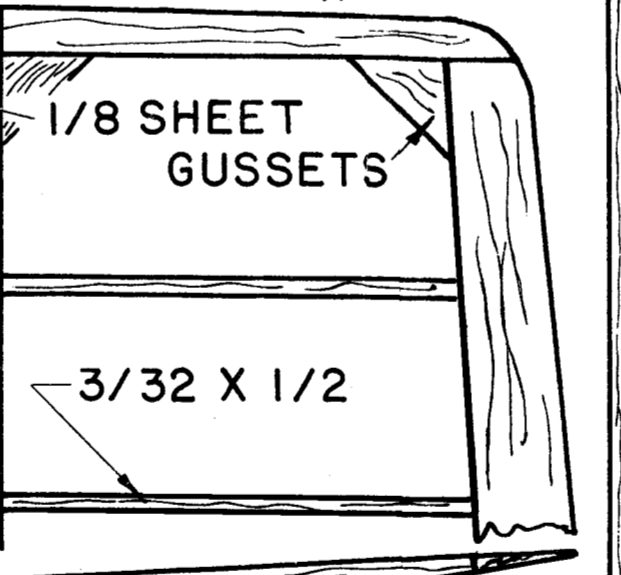
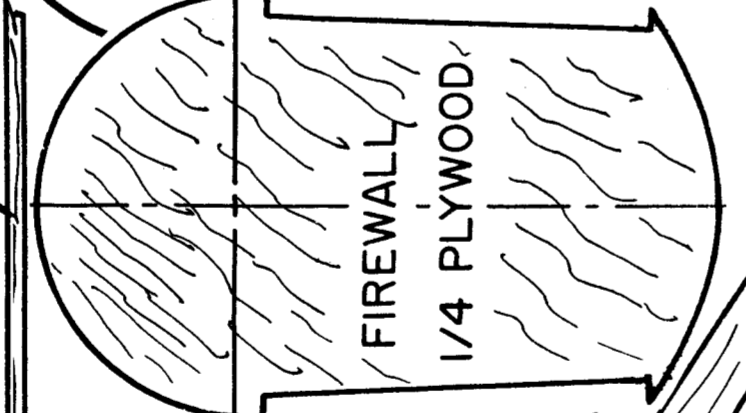
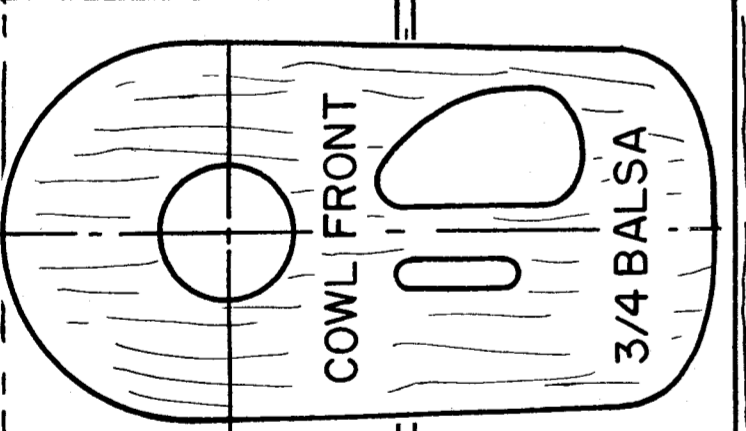
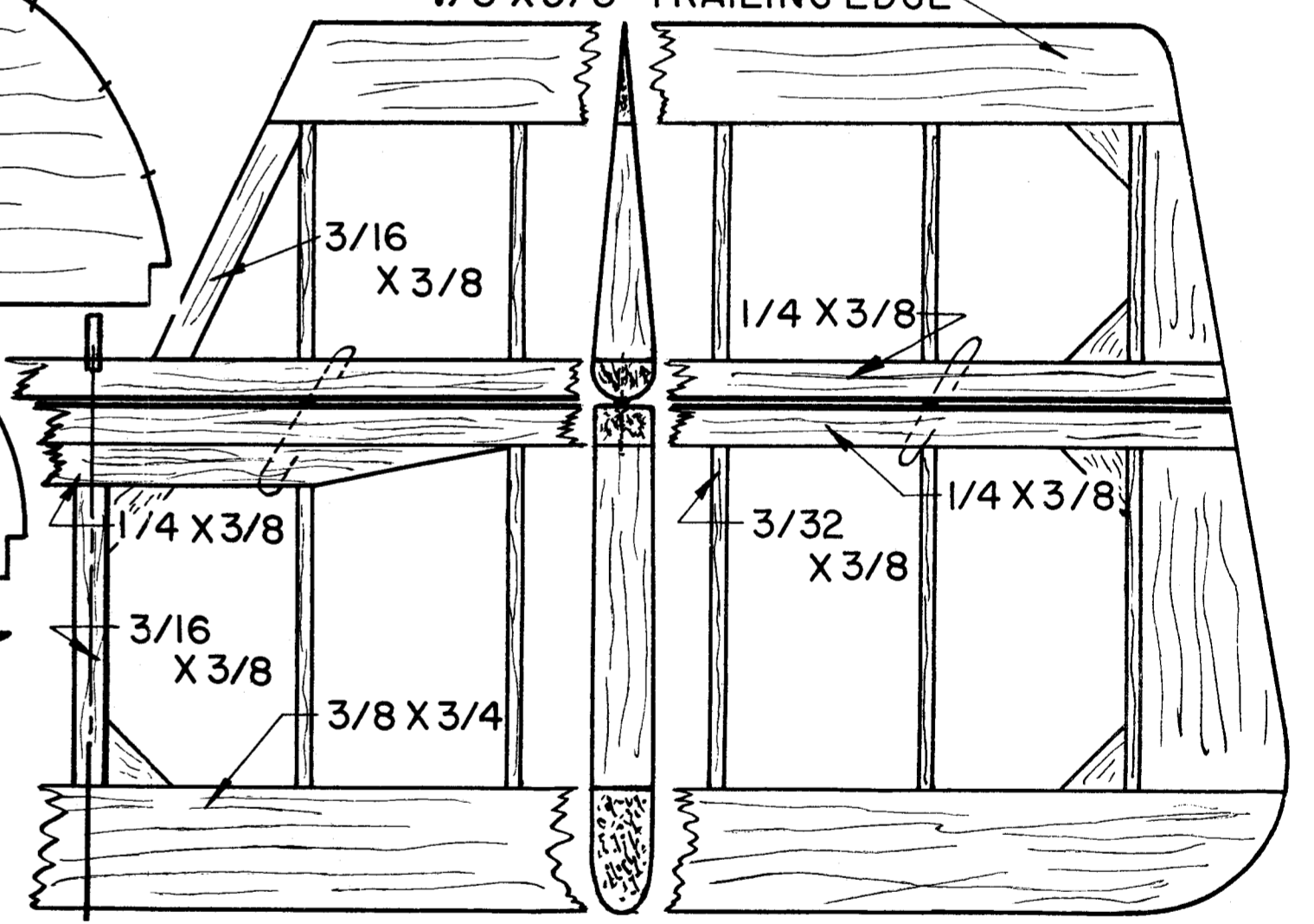
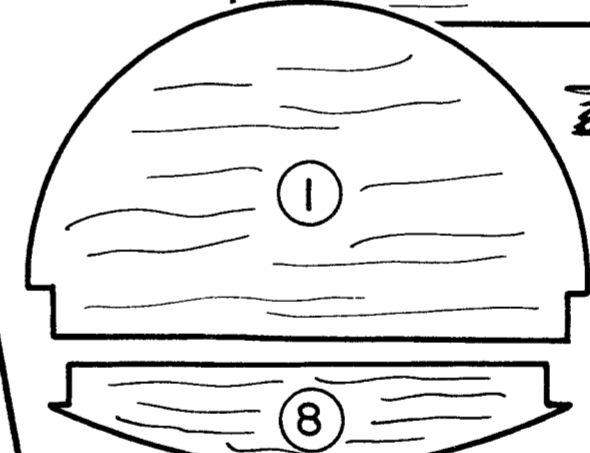
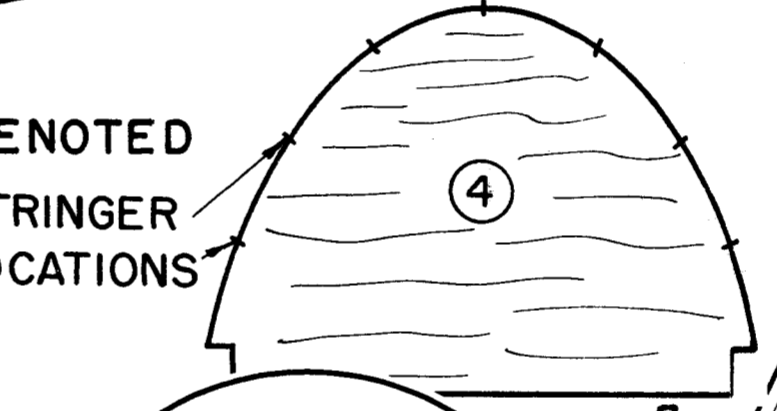

LEADOUT EYELETS

1/4 SHEET BUTT PLATES

3/32 WIRE GEAR

1/4 X 3/4 SPAR

1/2 X 3/8

1/4 X 1/2

5/8 X 1/8

WING RIB - 24 REQ'D. 3/32 SHT.

MODIFY THE 6 INBOARD RIBS TO DOTTED LINES.

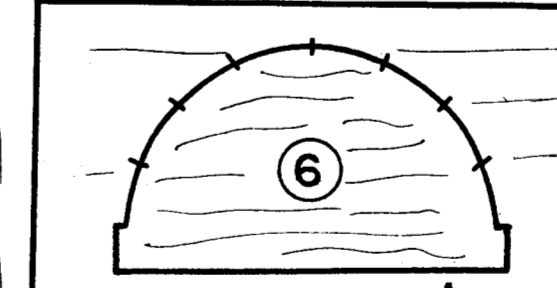

LOWER FILLET 2 REQ'D. (SEE TEXT)

FORMERS 1-8, 10, 11 ARE 1/8 SHEET.

UPPER FILLET 2 REQ'D. (SEE TEXT)

