

LINCOLN ELLSWORTHS
NORTHROP

GAMMA

Drawn for
FLYING ACES "Downunder"
by LLOYD WILLIS

SHEET 1

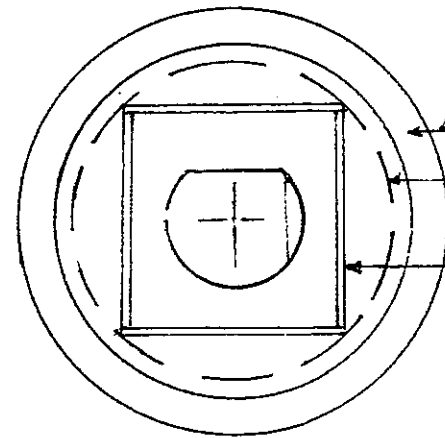
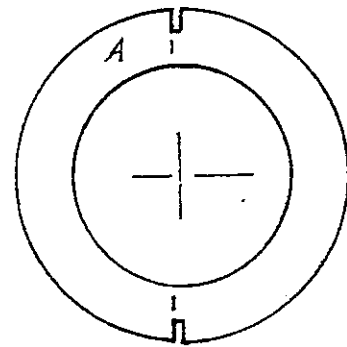

Laminate cowling
Inner cowling line
Cowling alignment box

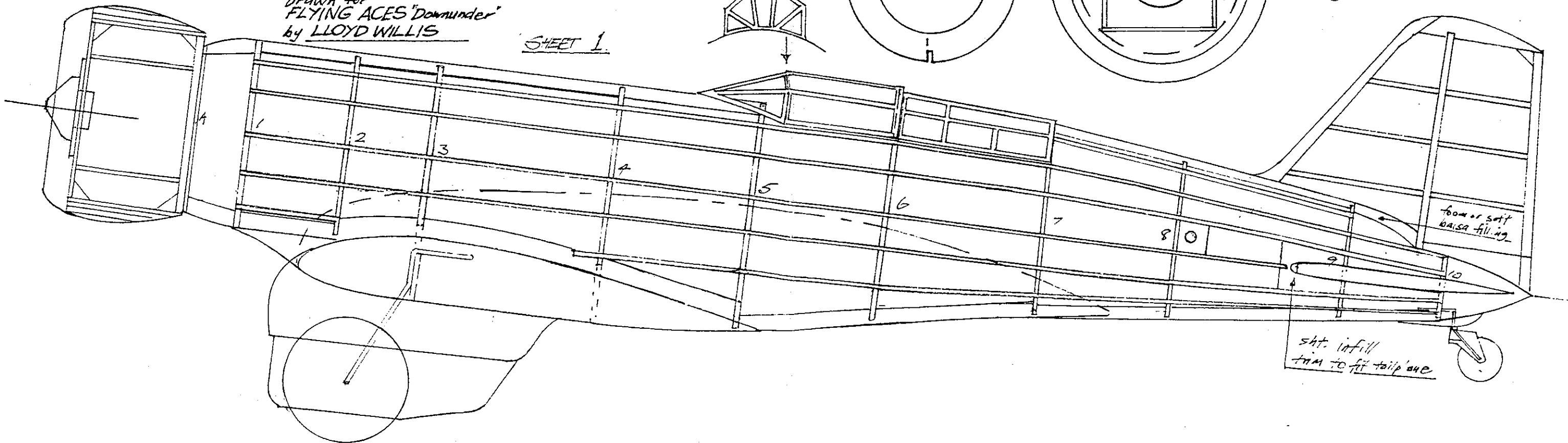

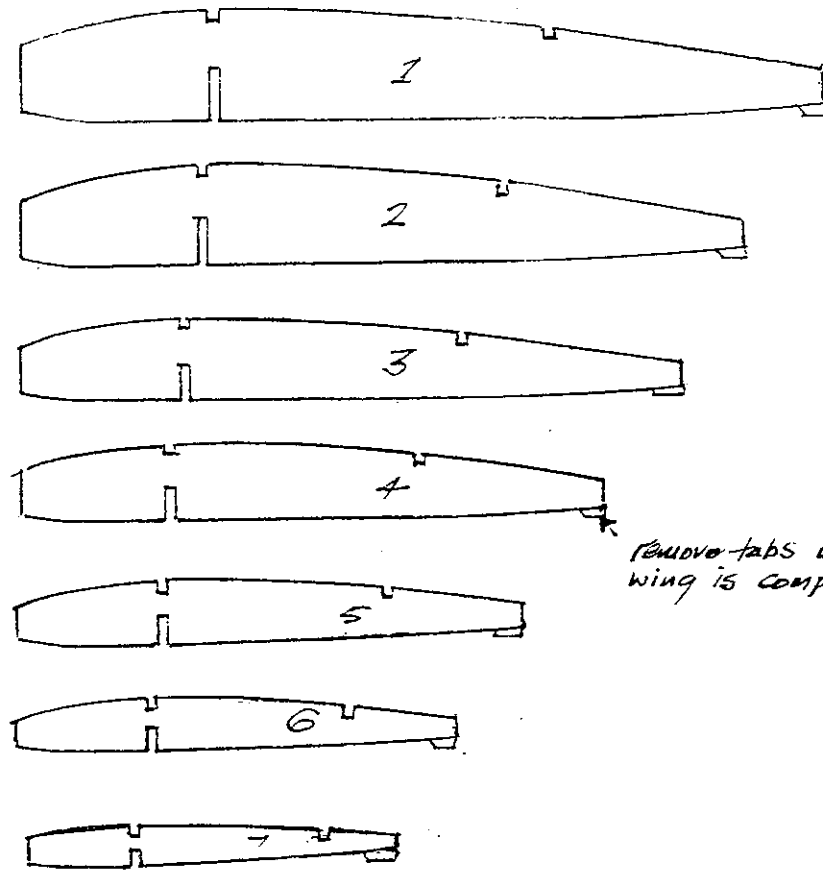

Remove tabs after wing is complete

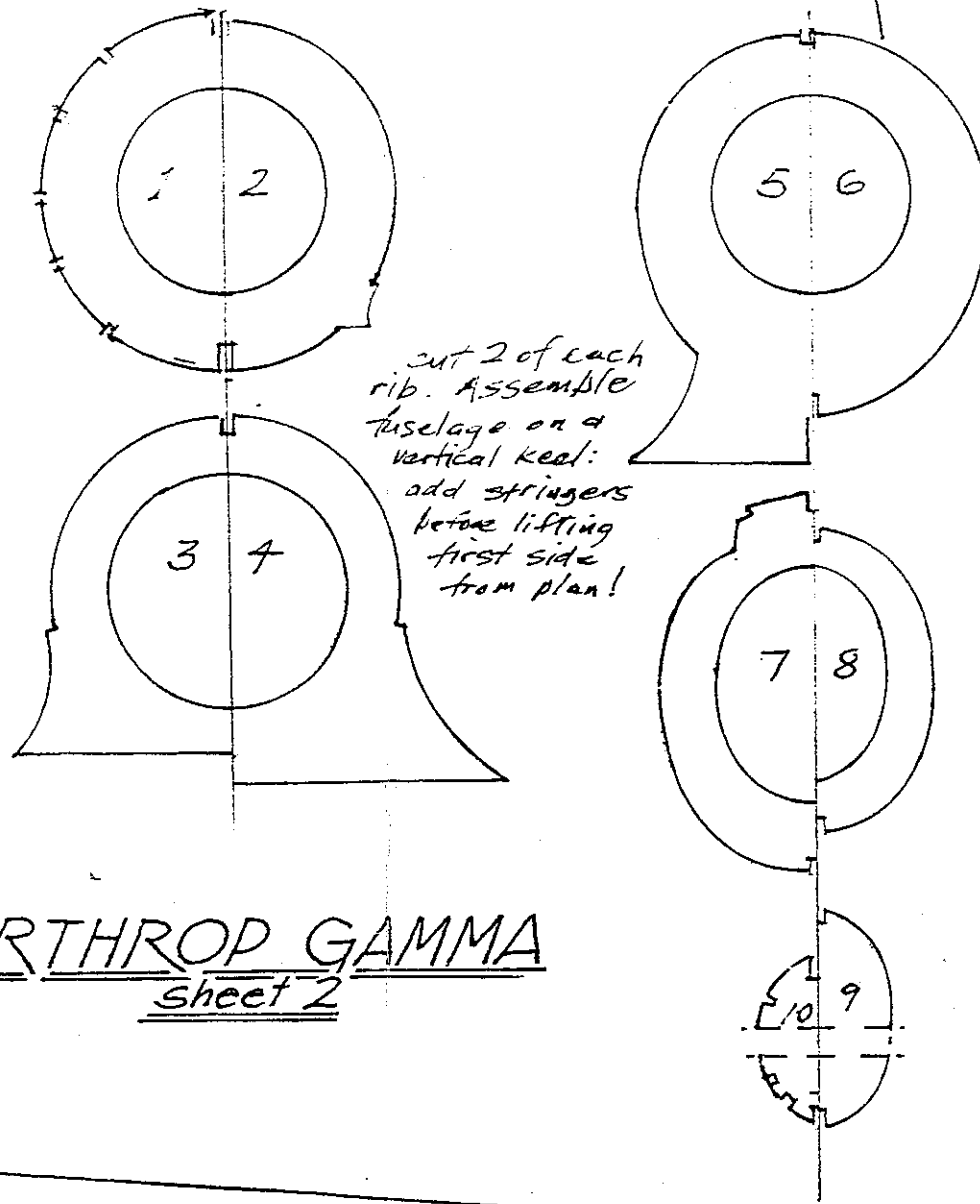

cut 2 of each rib. Assemble fuselage on a vertical keel. add stringers before lifting first side from plan!

NORTHROP GAMMA
Sheet 2

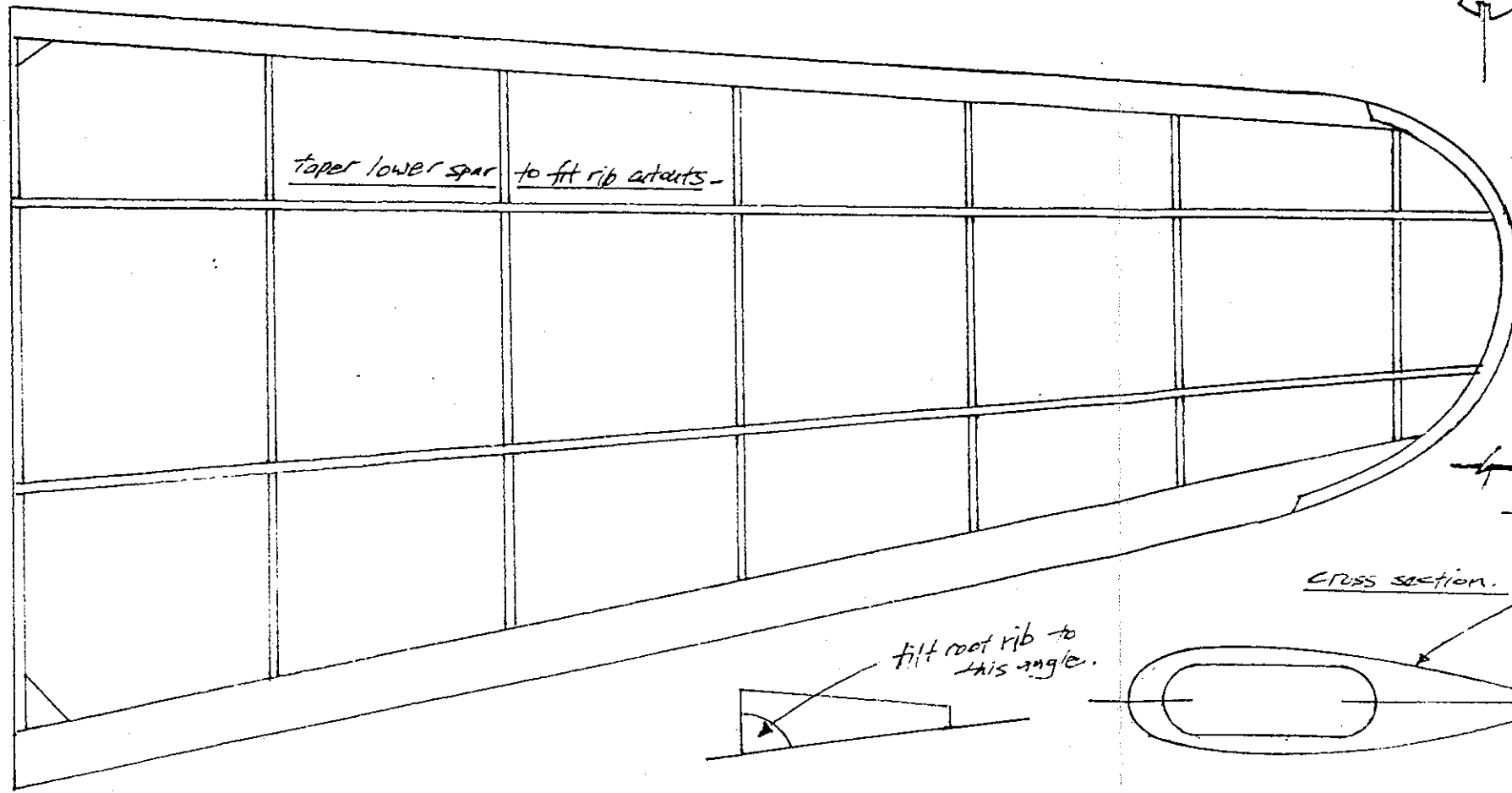
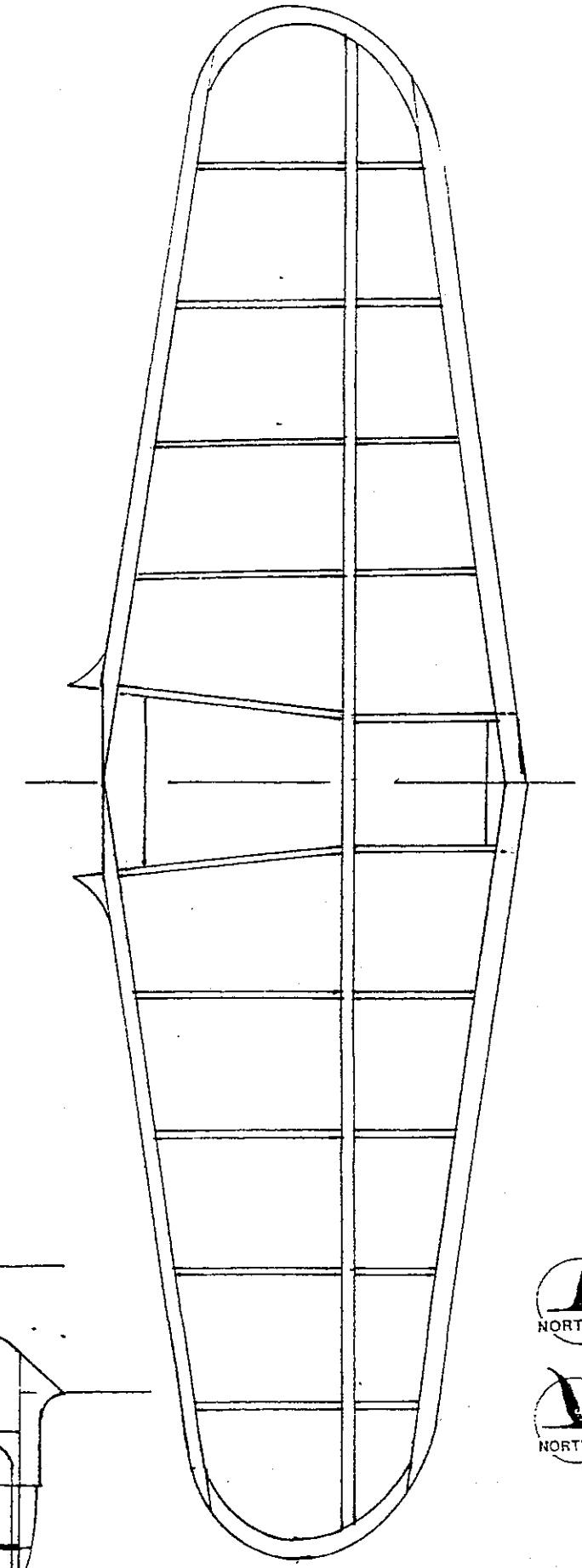

taper lower spar to fit rib cutouts-

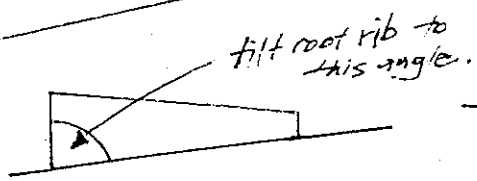

Cross section.

