

3mm EPP Parts (Page 1)

1/10 Semi-Scale Mini Cassutt

Original Design/Instructions by : Katsuhiko Toba

Original PDF Created by : Shinichi Kurita

English Translation by : Si Mills

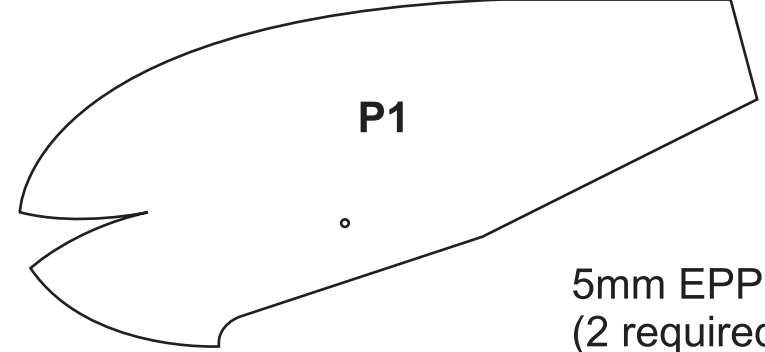
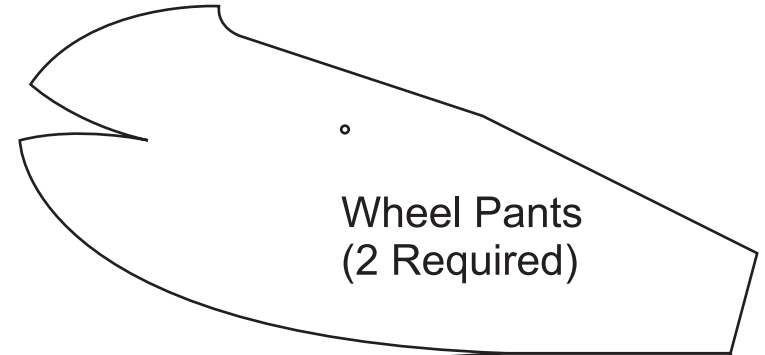

5mm EPP
(2 required)

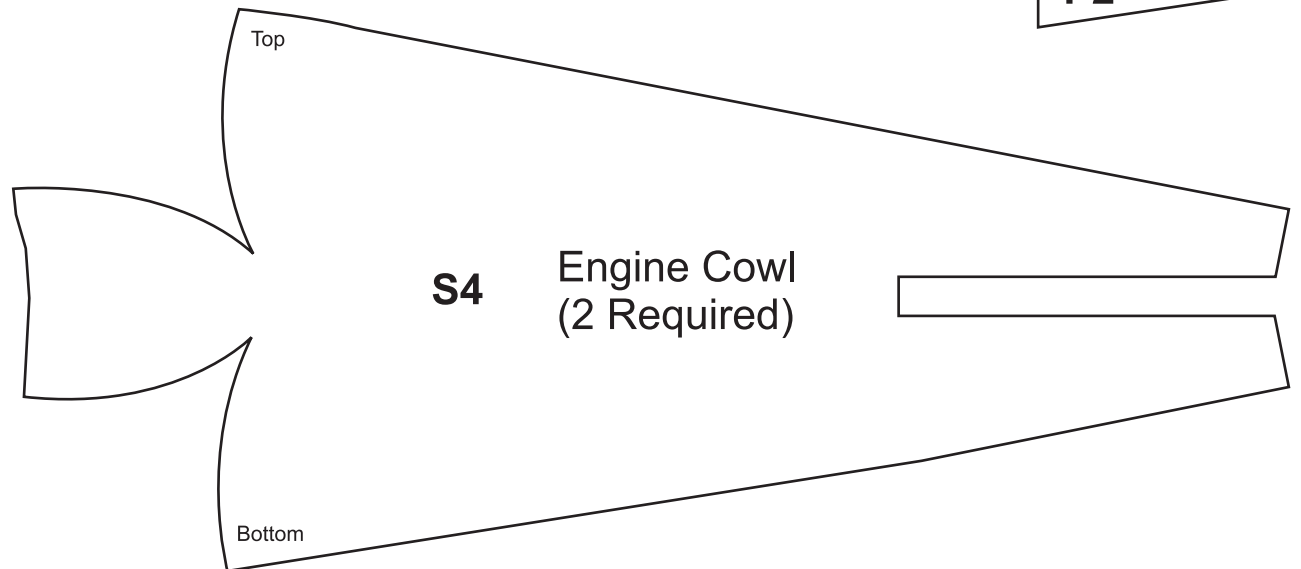

3mm EPP Parts (Page 2)

1/10 Semi-Scale Mini Cassutt

Original Design/Instructions by : Katsuhiko Toba

Original PDF Created by : Shinichi Kurita

English Translation by : Si Mills

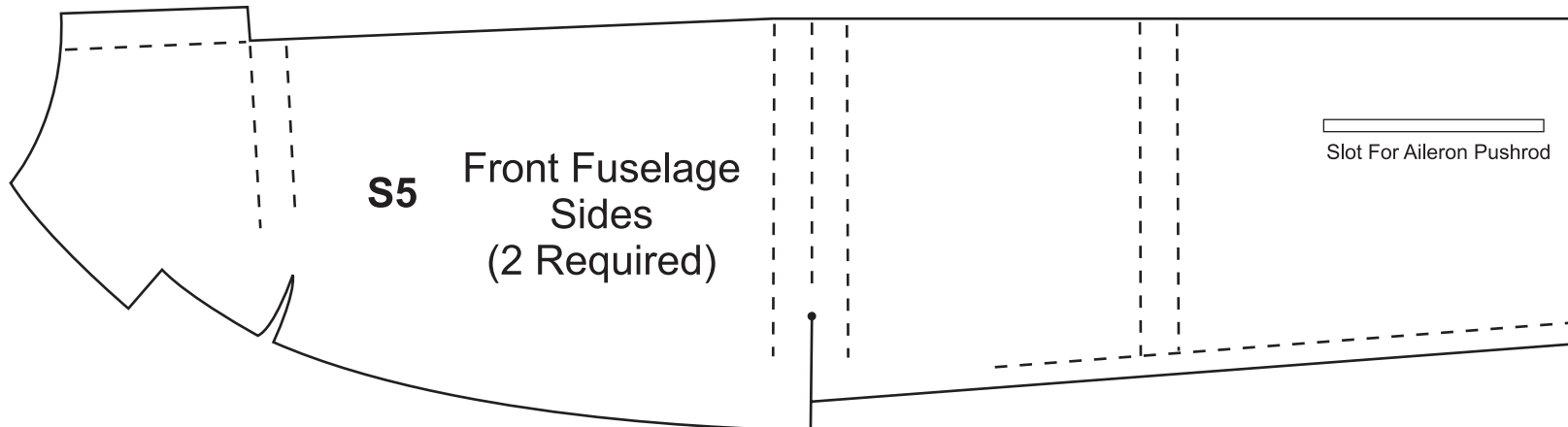
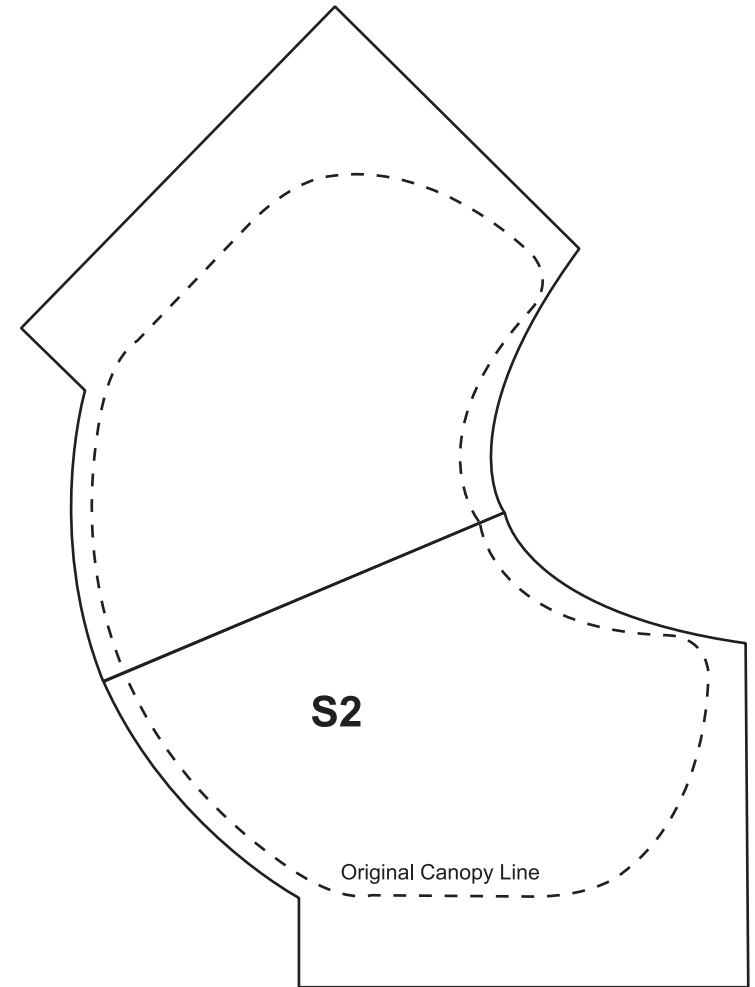
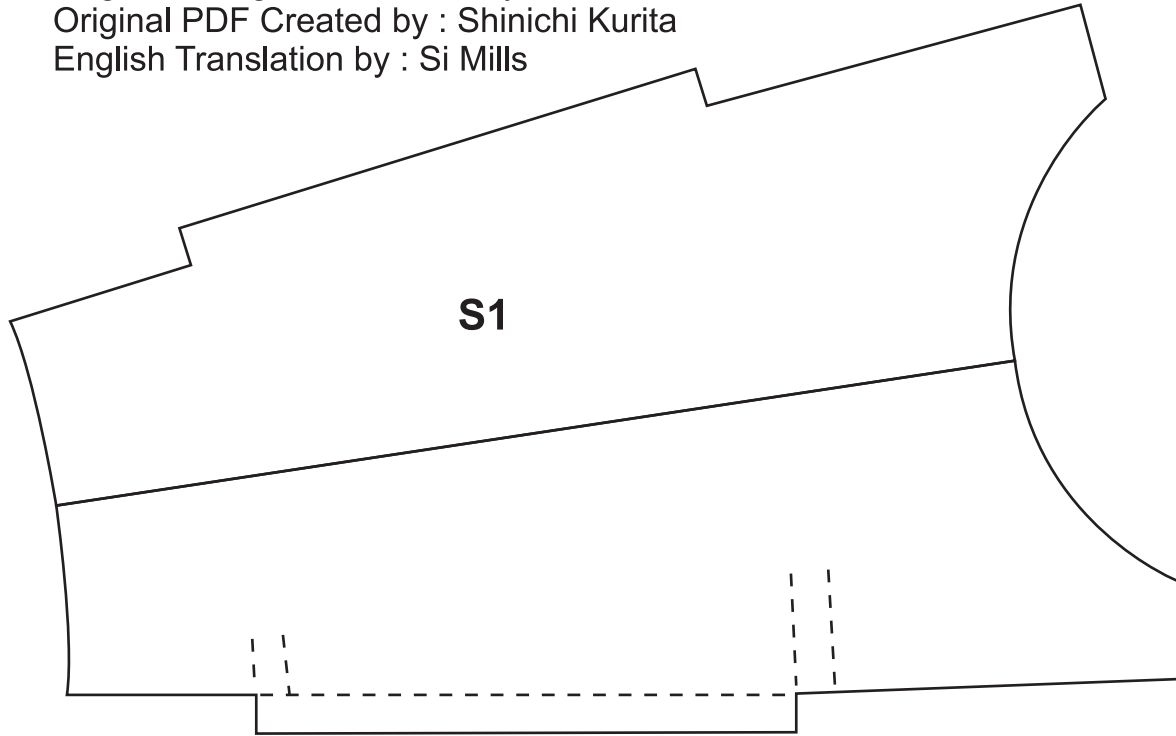

3mm EPP Parts (Page 3)

1/10 Semi-Scale Mini Cassutt

Original Design/Instructions by : Katsuhiko Toba

Original PDF Created by : Shinichi Kurita

English Translation by : Si Mills

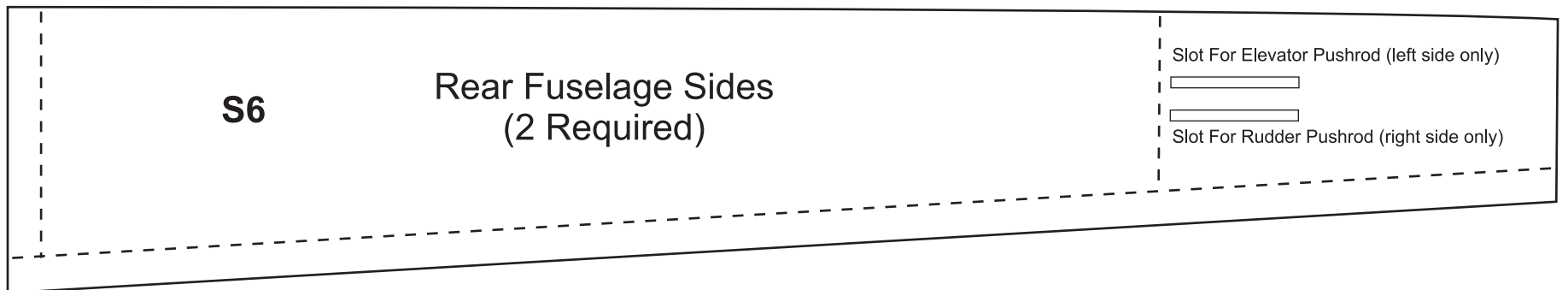
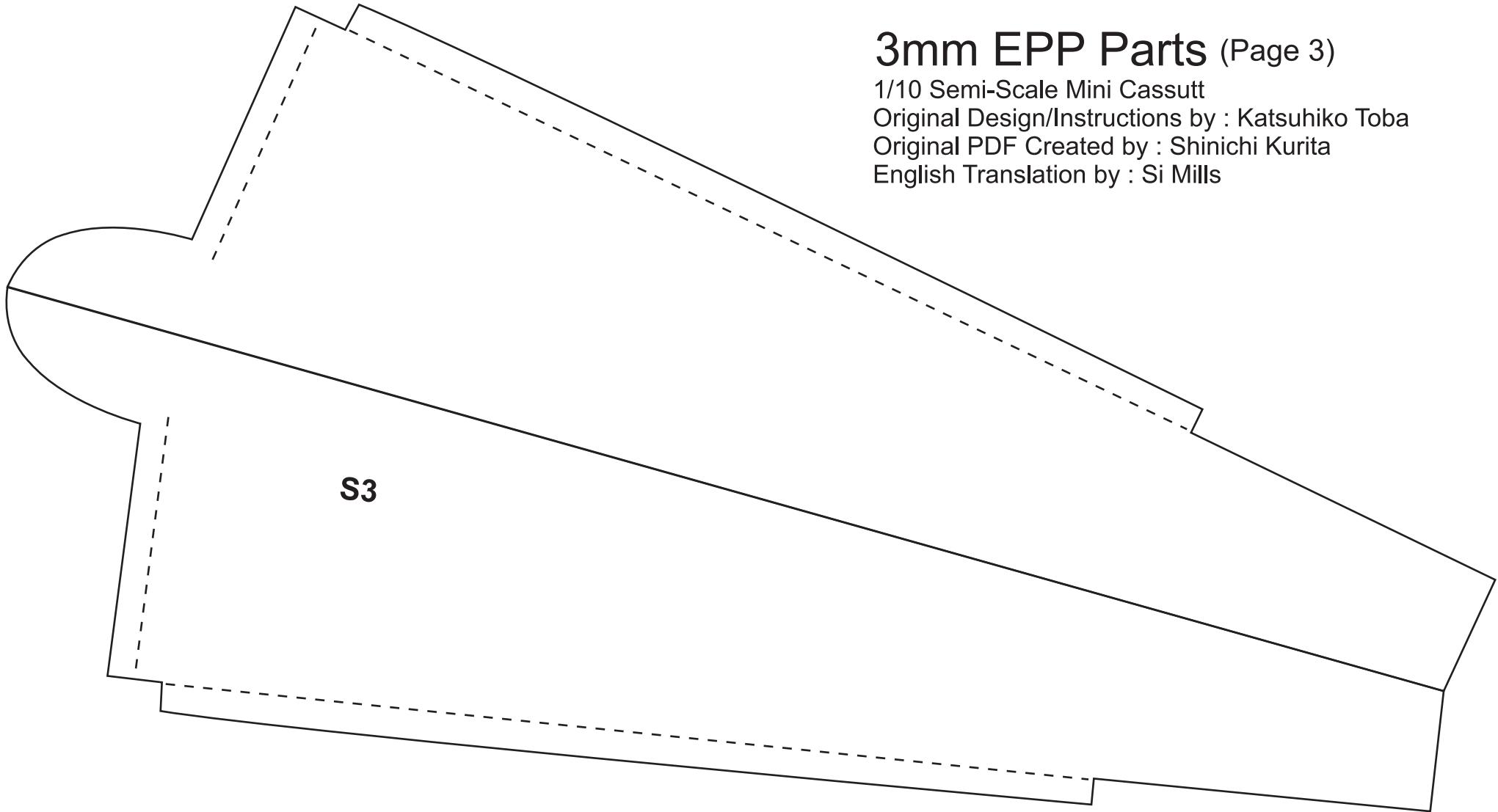

5mm EPP Parts (Page 1)

1/10 Semi-Scale Mini Cassutt

Original Design/Instructions by : Katsuhiko Toba

Original PDF Created by : Shinichi Kurita

English Translation by : Si Mills

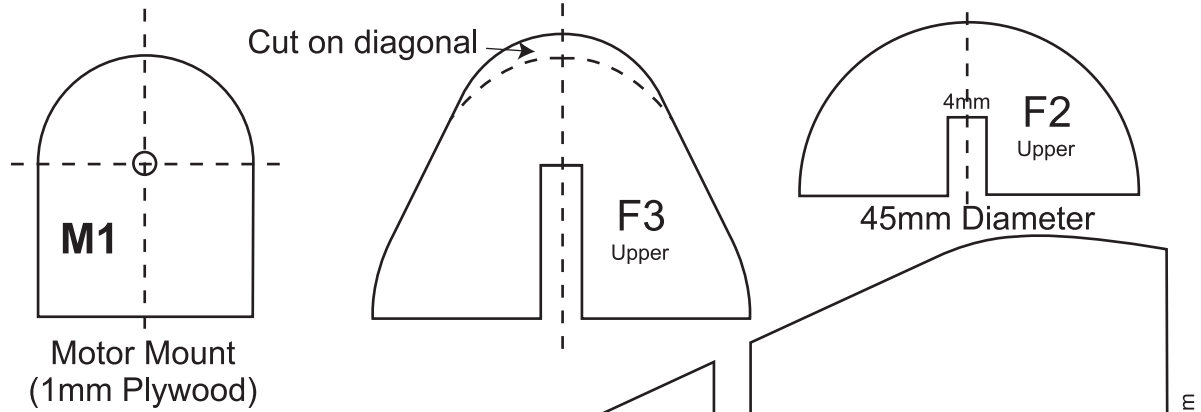

Cut hole later

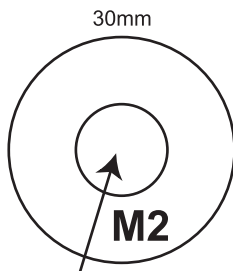
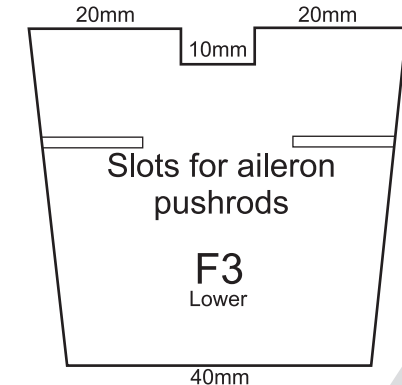
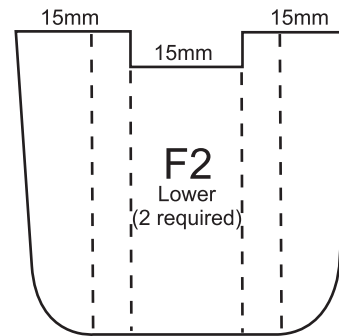
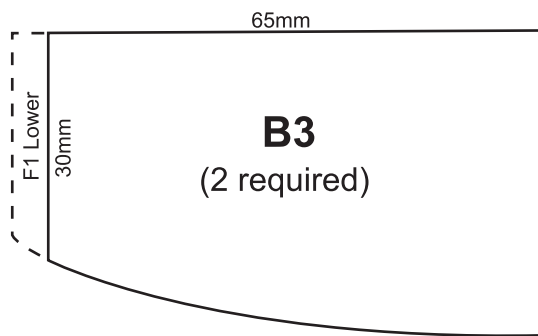
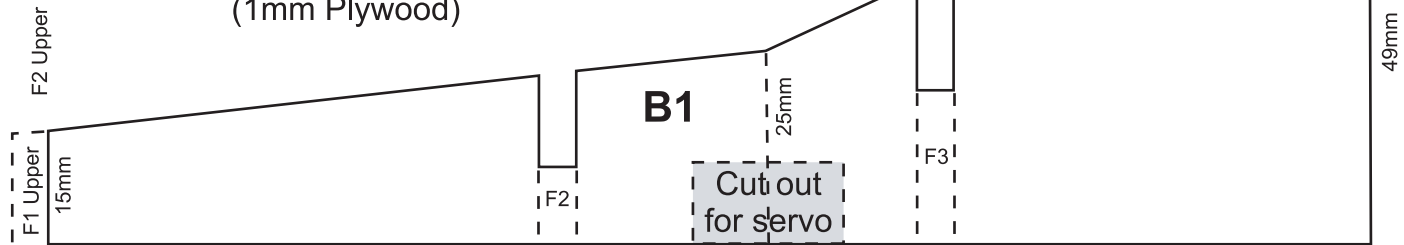
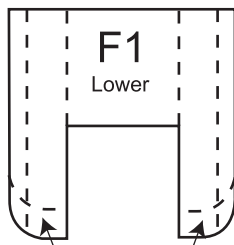
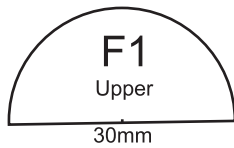
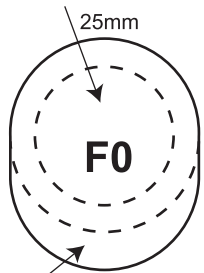

2 of these required for spinner

Cut 12mm Diameter Hole For Propeller

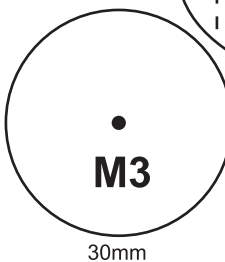

4 of these required for spinner

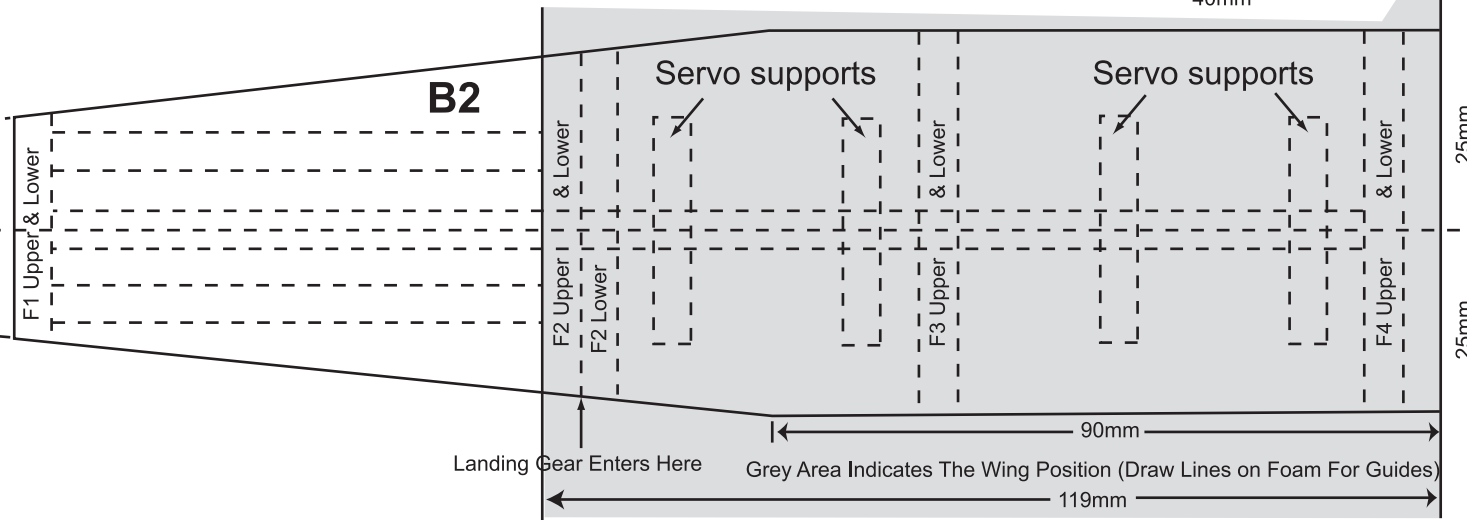

5mm EPP Parts (Page 2)

1/10 Semi-Scale Mini Cassutt

Original Design/Instructions by : Katsuhiko Toba

Original PDF Created by : Shinichi Kurita

English Translation by : Si Mills

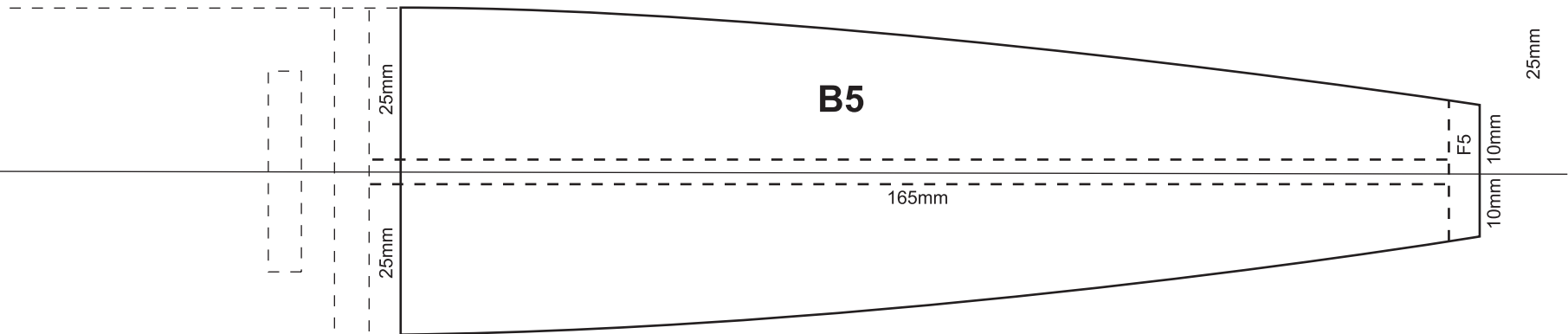
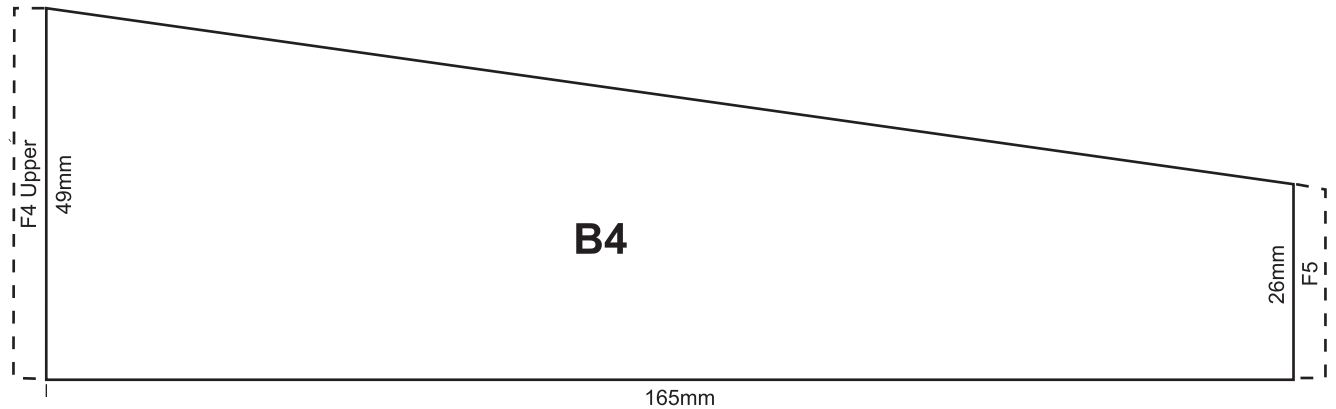
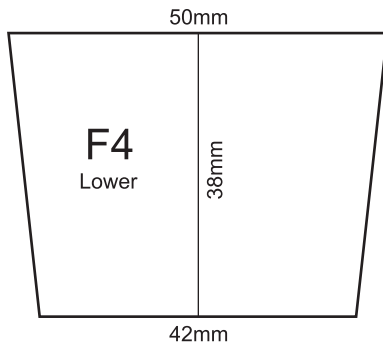
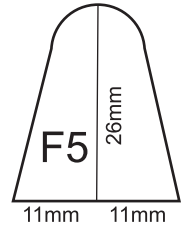
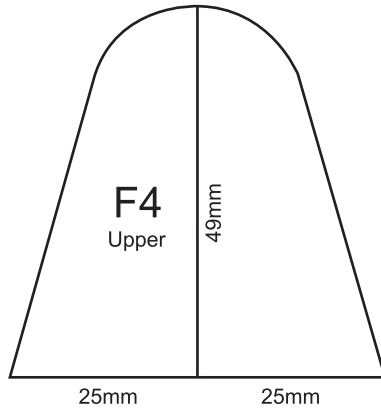

5mm EPP Parts (Page 3)

1/10 Semi-Scale Mini Cassutt

Original Design/Instructions by : Katsuhiko Toba

Original PDF Created by : Shinichi Kurita

English Translation by : Si Mills

Trim this area to increase space for radio if necessary

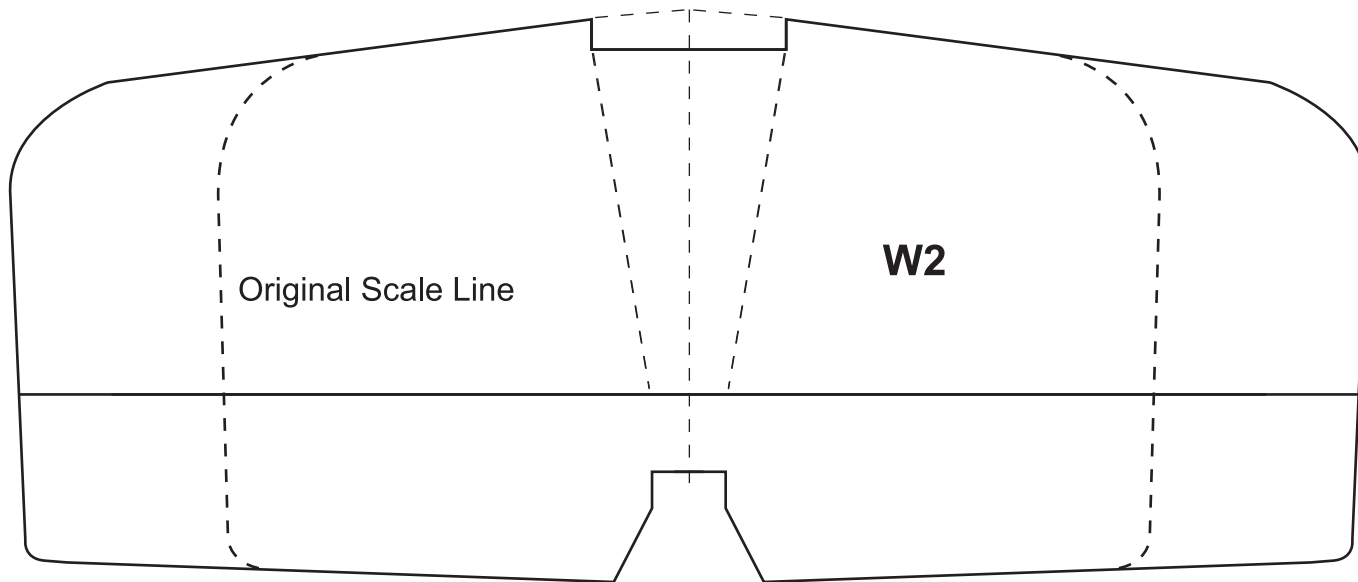
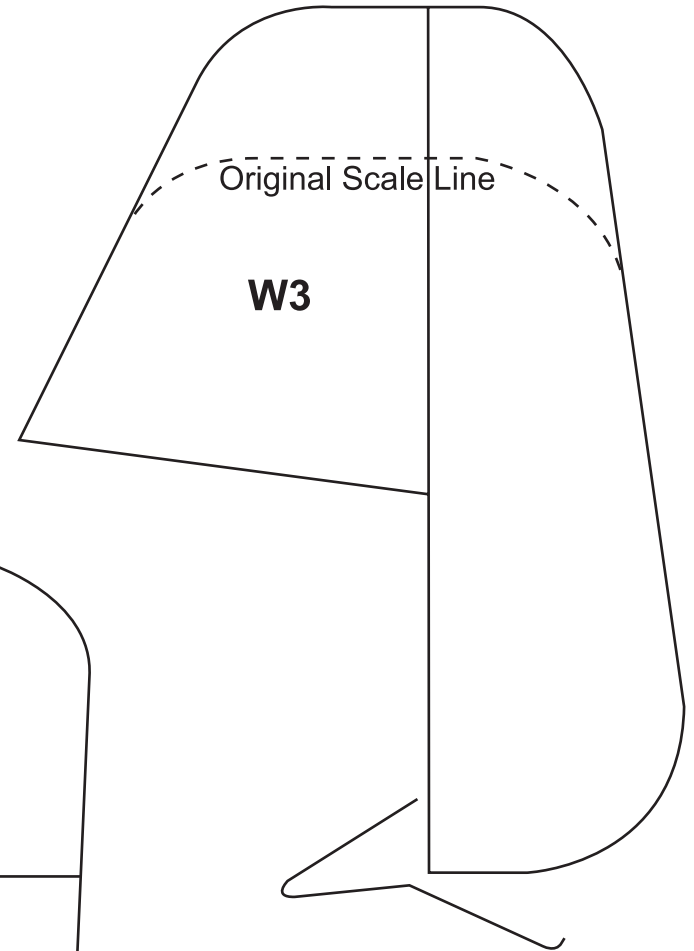
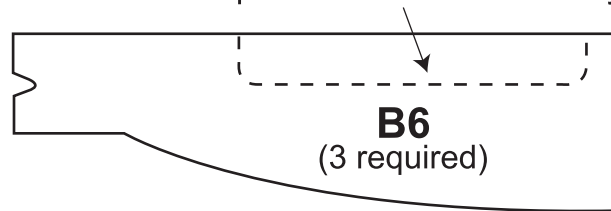

Tail Skid
(1mm Music/Piano Wire)

The diagram shows a small, hook-like shape representing the tail skid, which is intended to be made from 1mm music or piano wire.

5mm EPP Parts (Page 4)

1/10 Semi-Scale Mini Cassutt

Original Design/Instructions by : Katsuhiko Toba

Original PDF Created by : Shinichi Kurita

English Translation by : Si Mills

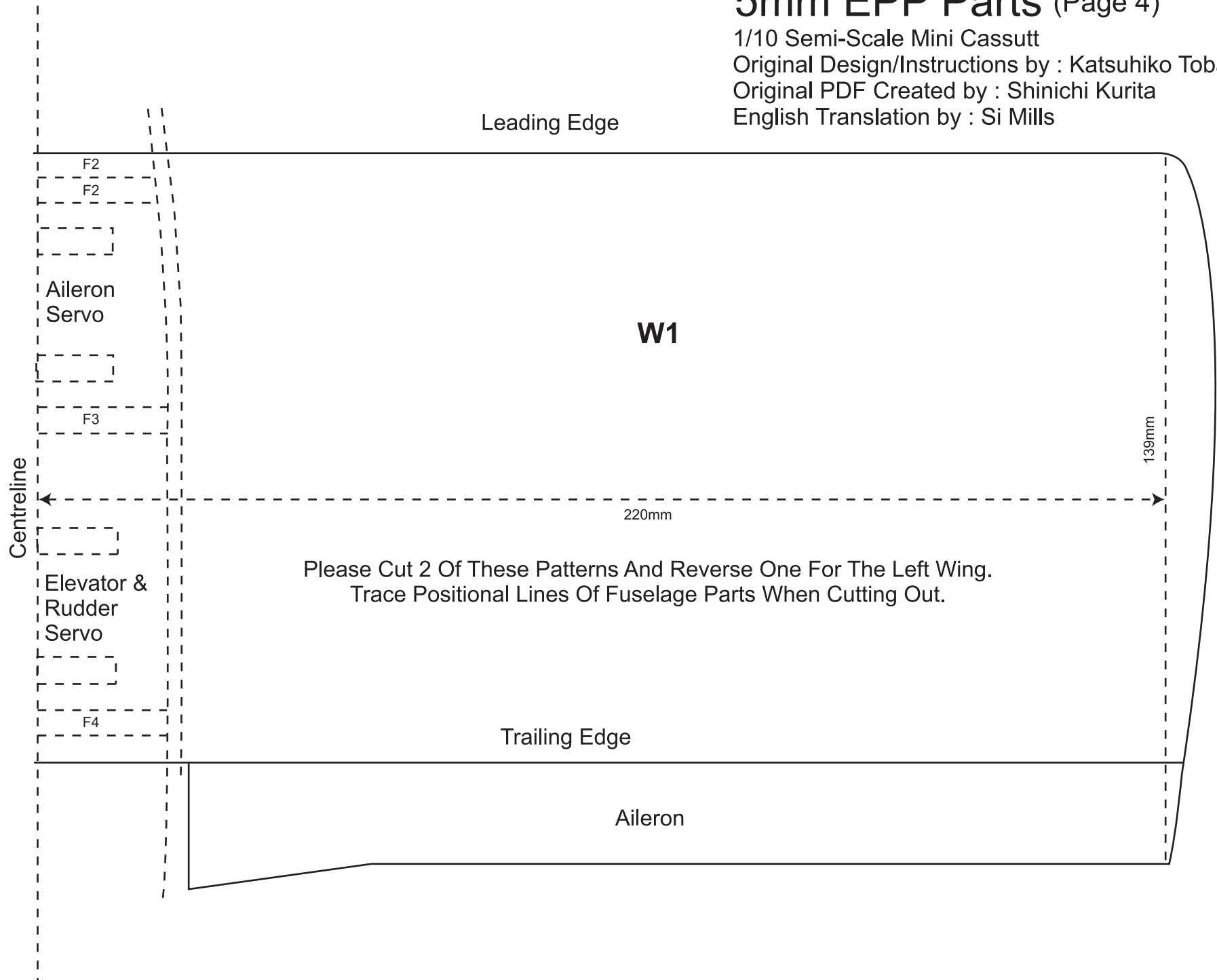

5mm EPP Parts (Page 5)

1/10 Semi-Scale Mini Cassutt

Original Design/Instructions by : Katsuhiko Toba

Original PDF Created by : Shinichi Kurita

English Translation by : Si Mills

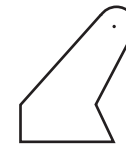
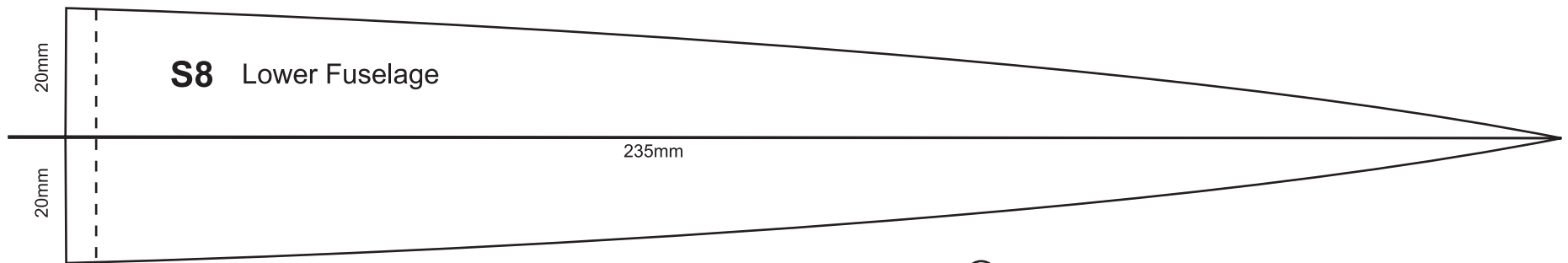
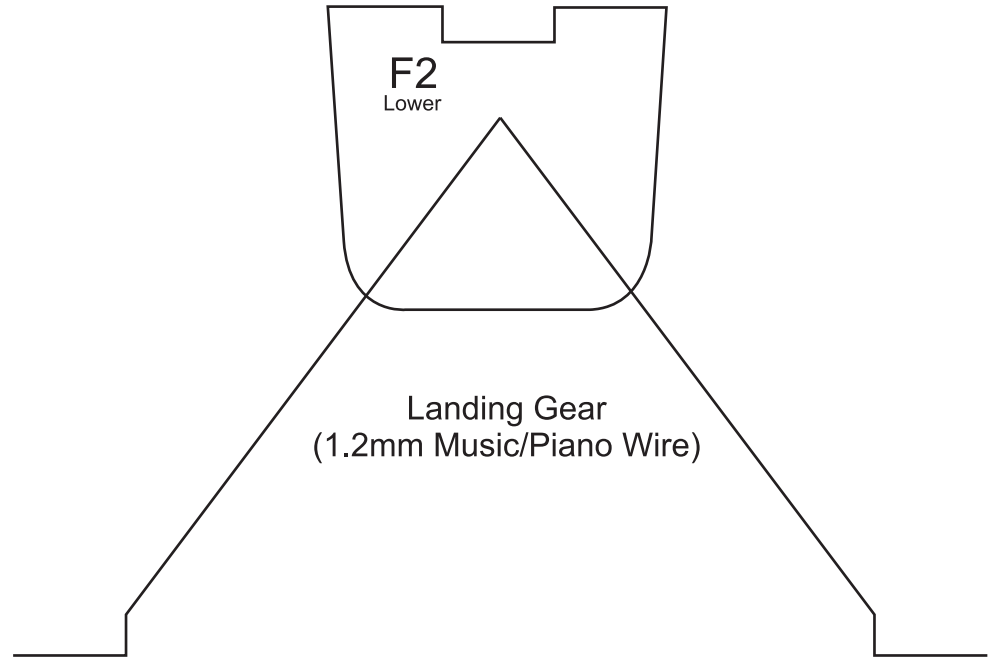
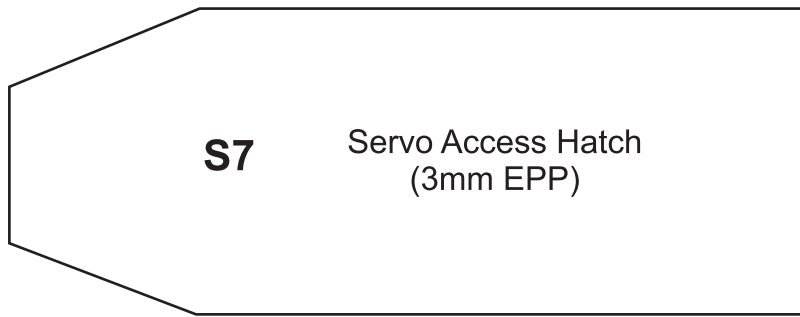

Control Horns
(1mm Plywood)