

Tern

DESIGNED BY: BILL WINTER
 PLANS BY: JOHN HUNTON

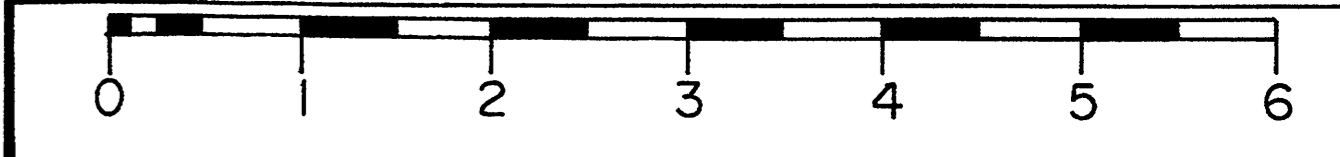

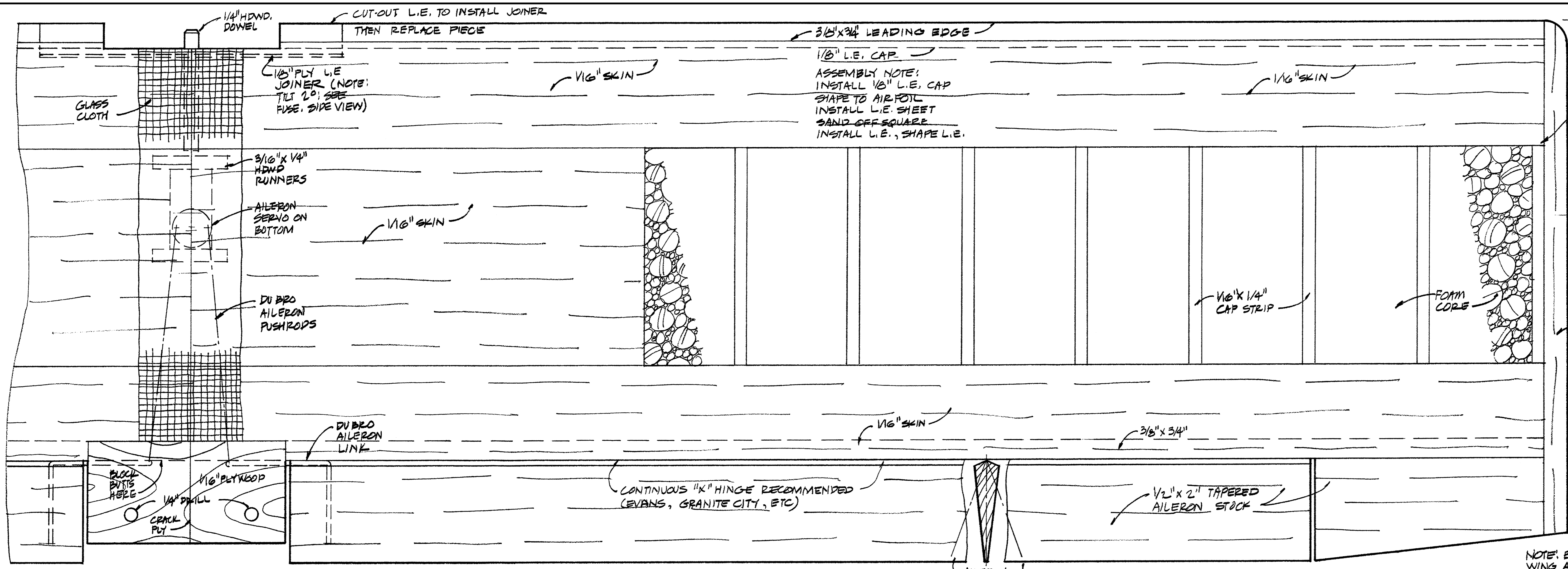

FOAM CORE WING PANEL SHOWN

SUGGESTION! SPRAY WING PLAN WITH WD-40 TO MAKE IT TRANSPARENT FOR CONSTRUCTING OPPOSITE SIDE WING PANEL.

NOTE: BLOCK UP EACH TIP 1 5/8" FOR DIHEDRAL

NOTE: BOTTOM OF WING AT TIP IS SHAPED UP FOR "WASHOUT"

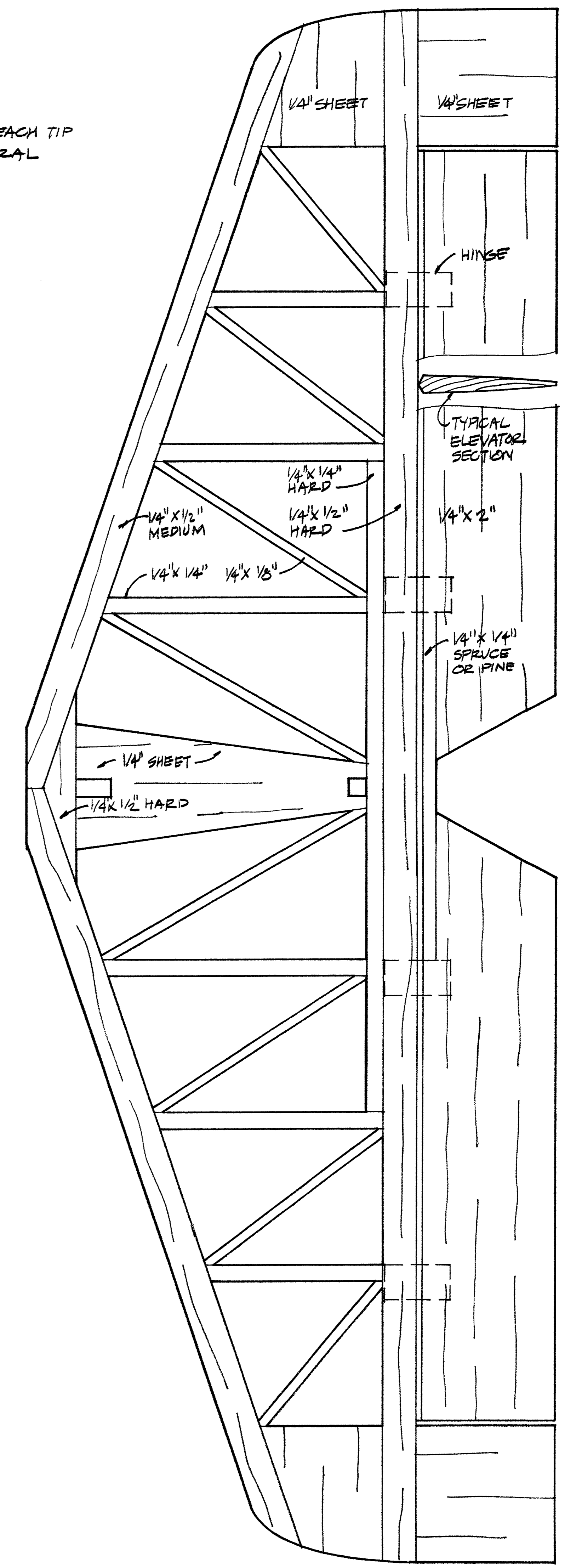

TYPICAL ELEVATOR SECTION

NOTE: BLOCK UP EACH TIP 1 5/8" FOR DIHEDRAL

1/2" SHEET W/ ROUNDED EDGES

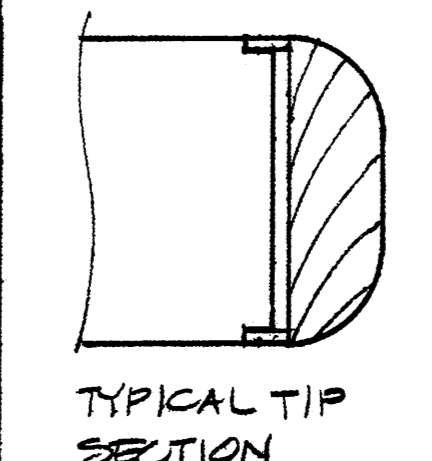

TYPICAL TIP SECTION

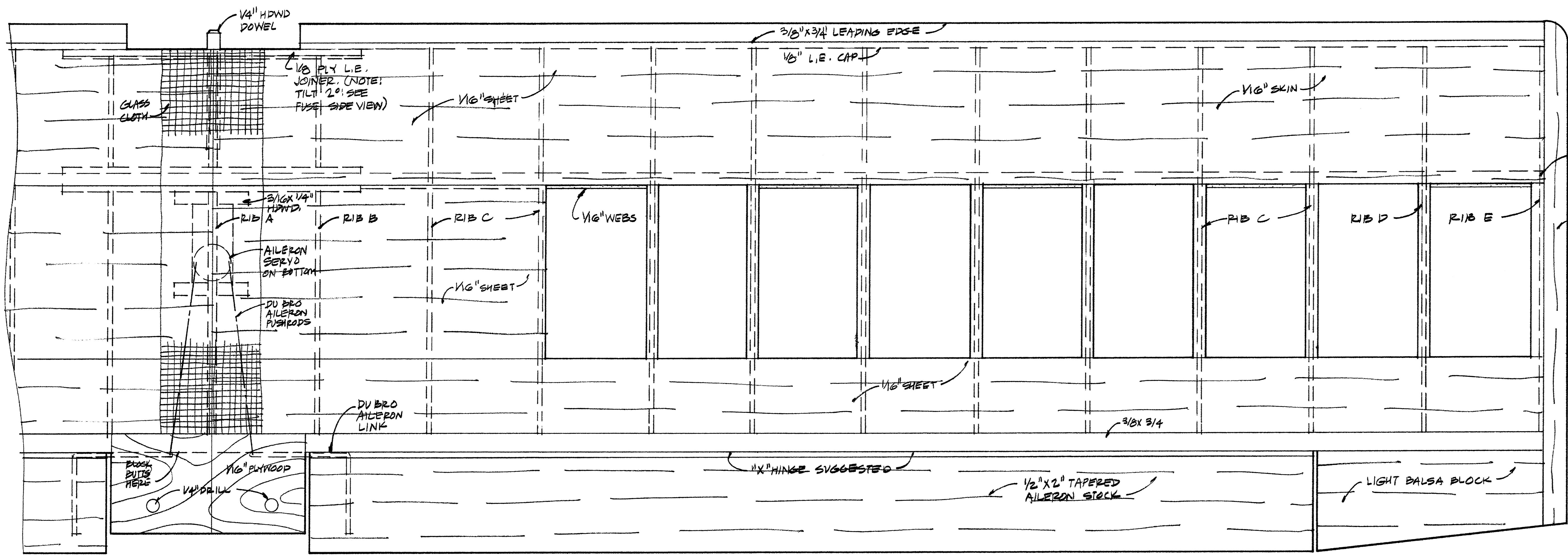

ALTERNATE BUILT-UP WING PANEL SHOWN

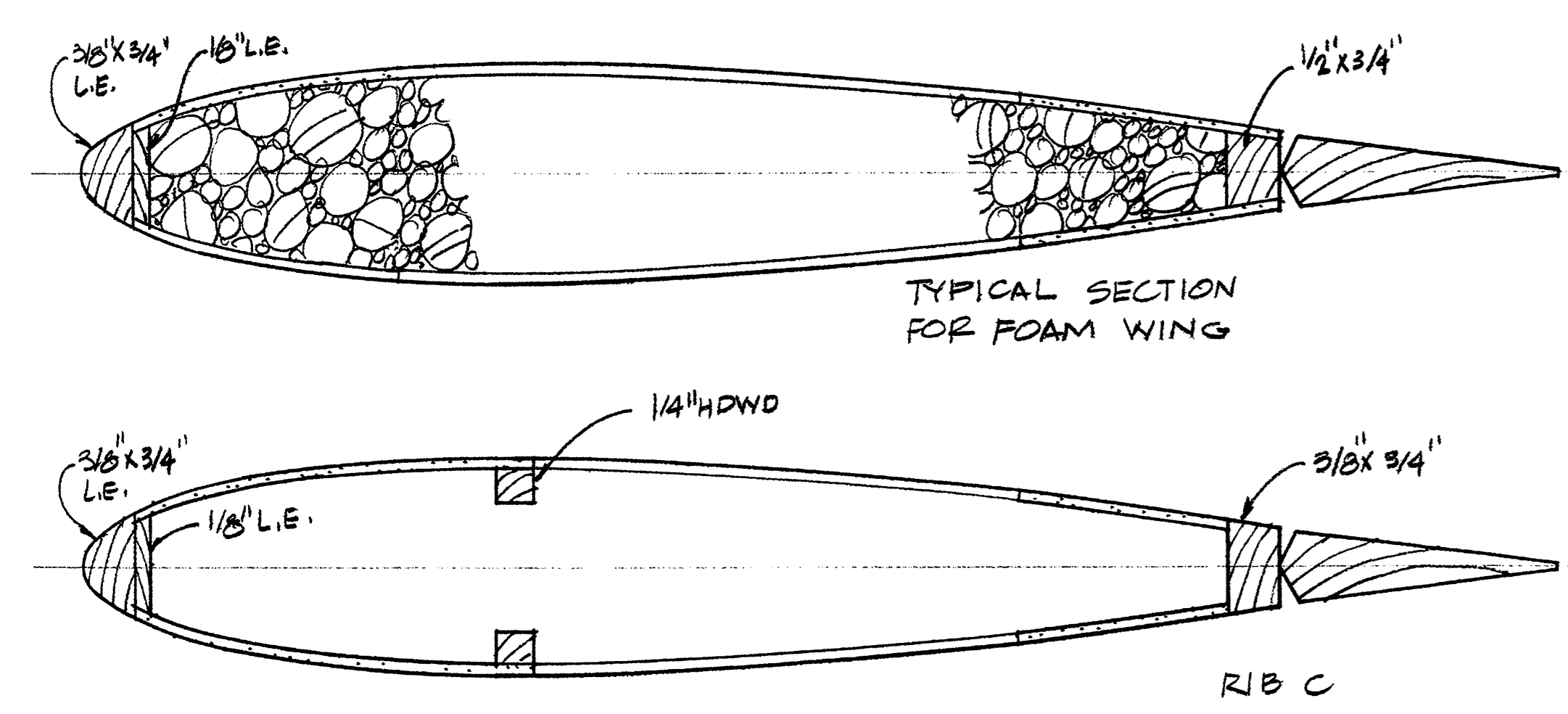

TYPICAL SECTION FOR FOAM WING

RIB C

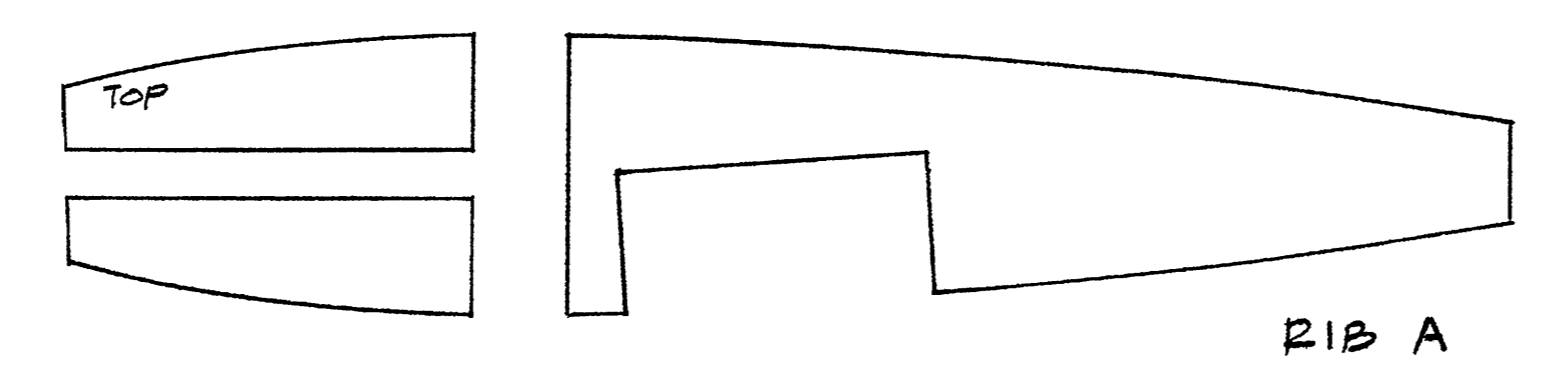

RIB A

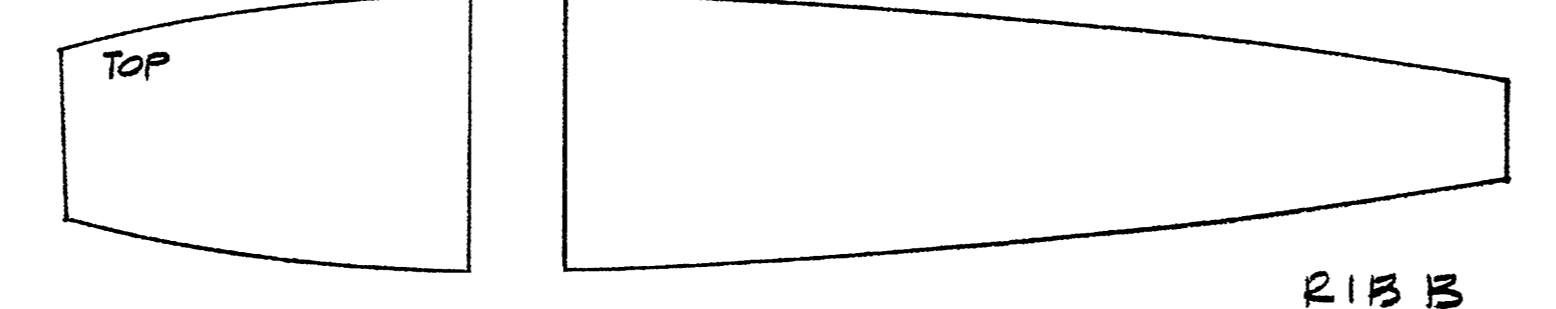

RIB B

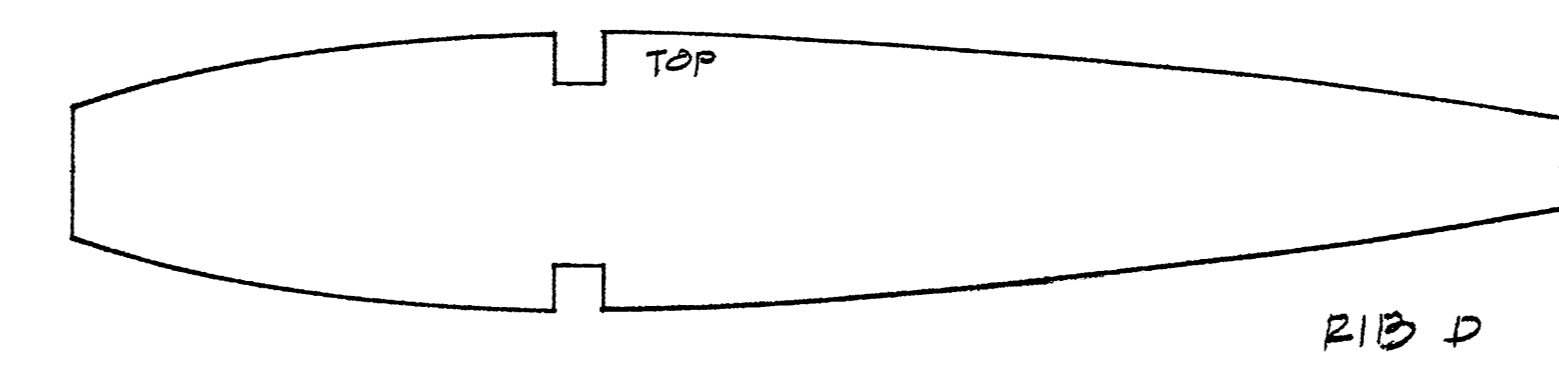

RIB D



RIB E

RIBS FOR BUILT-UP WINGS 3/32" SHEET

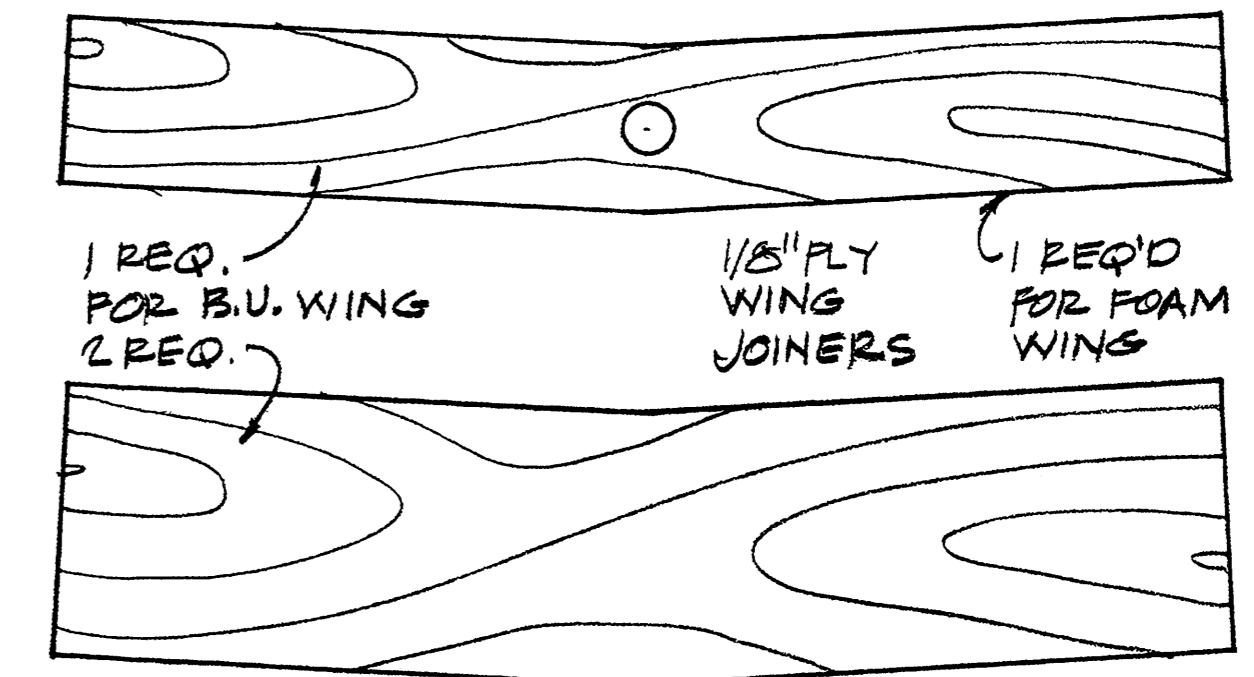

1 REQ. FOR B.U. WING (2 REQ.)

1/8" PLY WING JOINERS

1 REQ. FOR FOAM WING

© RCM ALL COMMERCIAL RIGHTS RESERVED

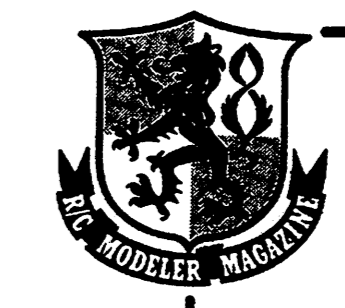

Tern

DESIGNED BY: BILL WINTER

PLANS BY: JOHN HUNTON

