

LANDING GEAR BENT FROM 3/16 DRILL ROD & COMMERCIAL HARDENED

LENGTH WILL VARY ACCORDING TO WHEELS USED

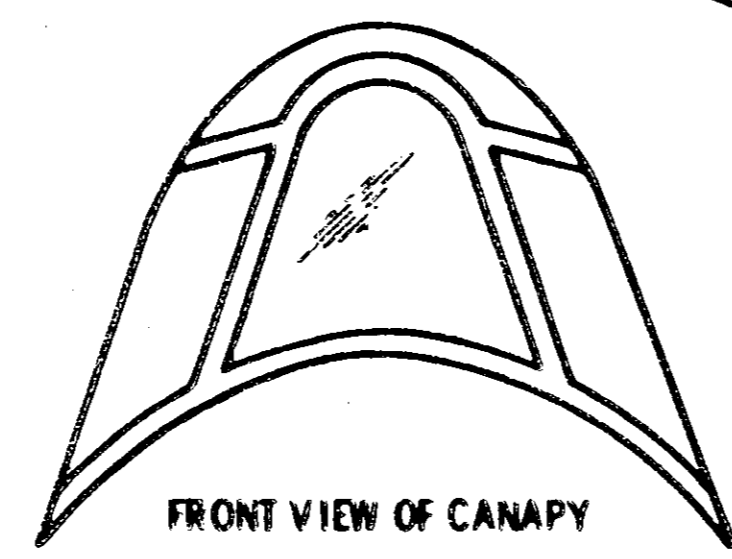

WING FILLET MADE FROM Balsa (EITHER BUILD UP FROM SHEET OR BLOCK)

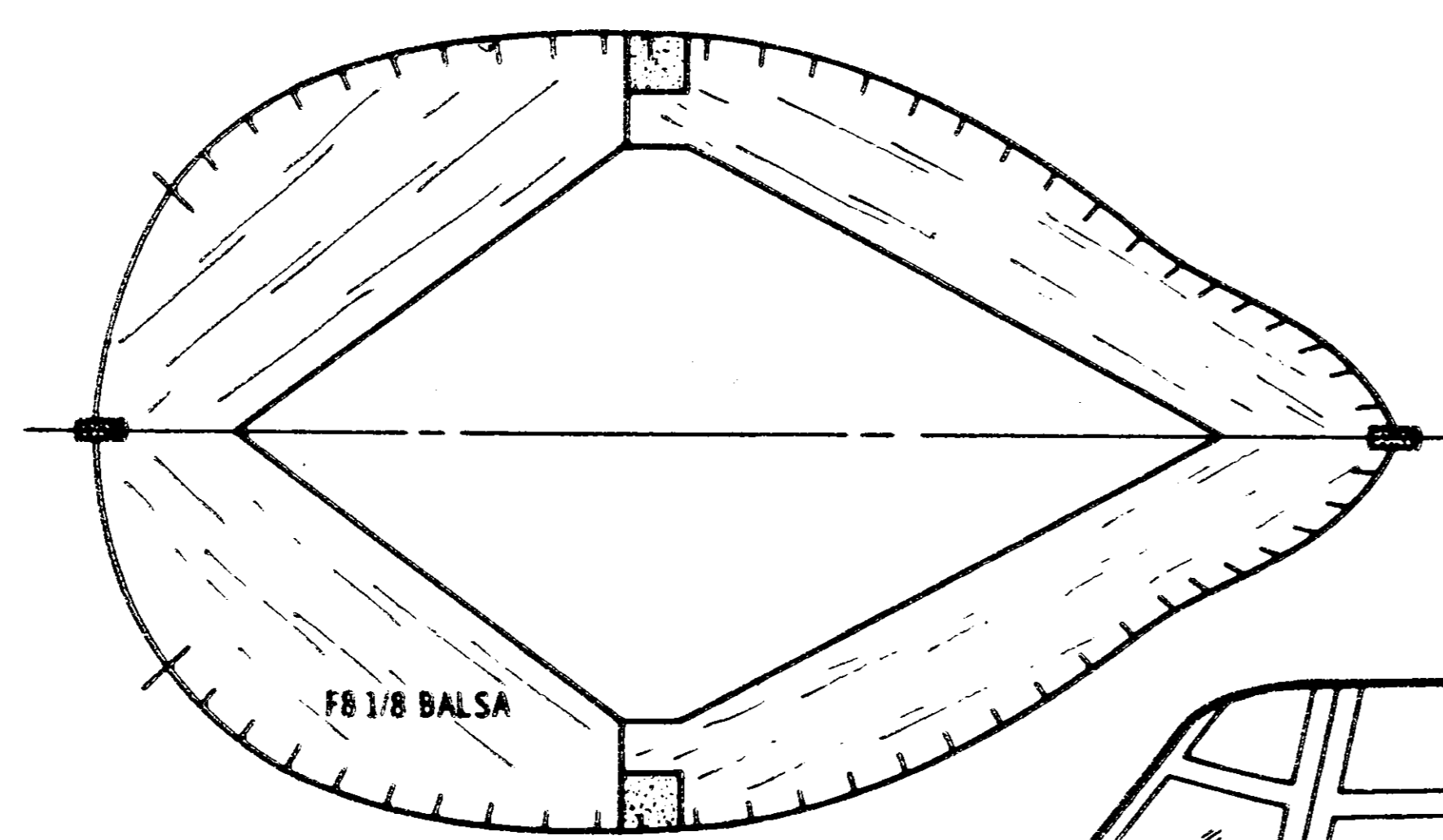
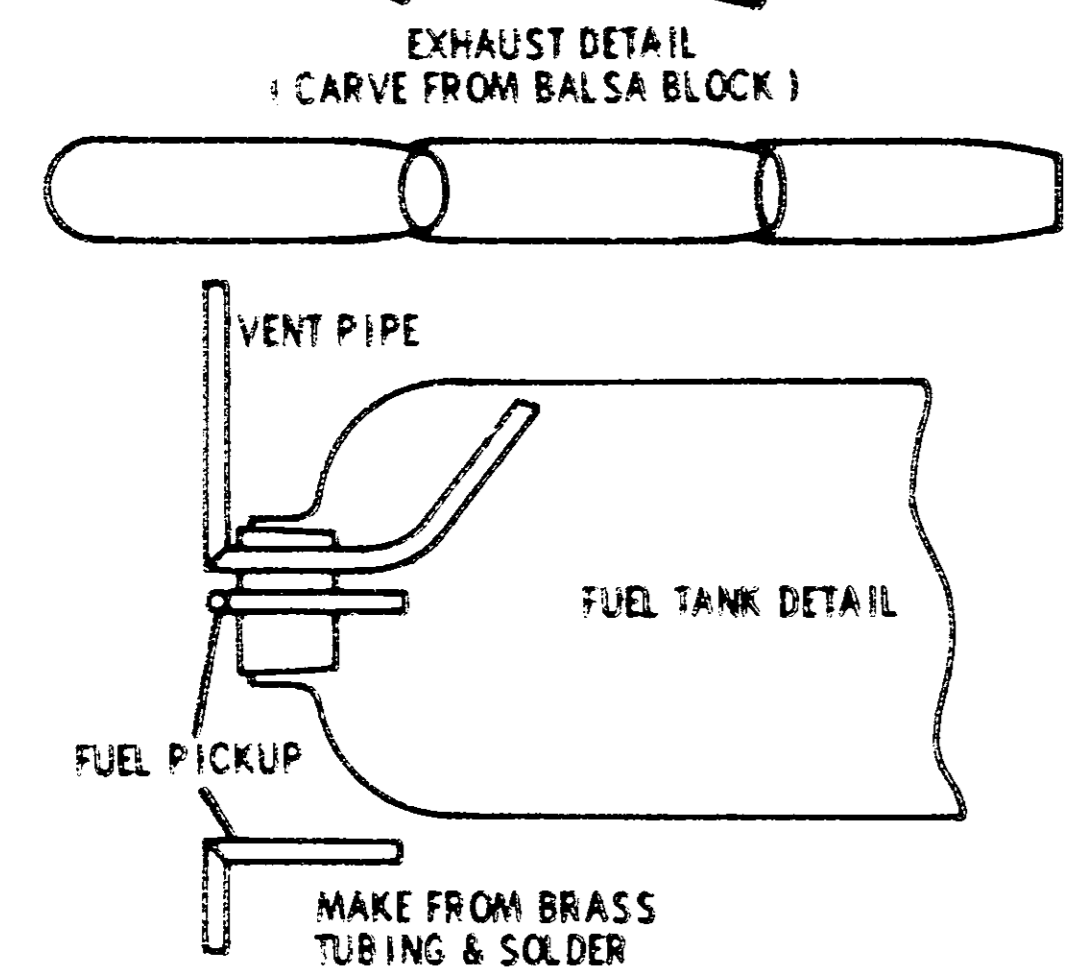
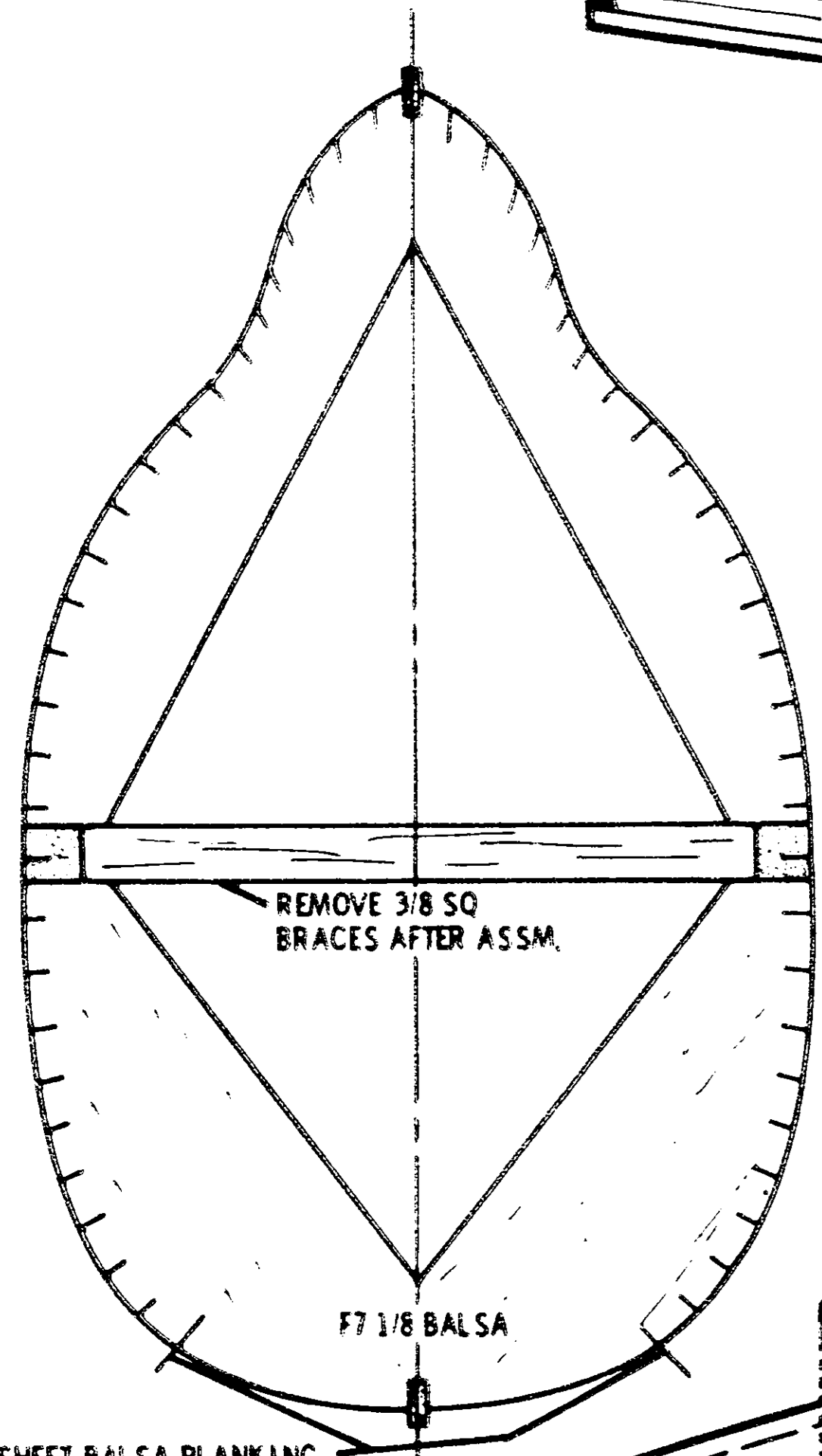
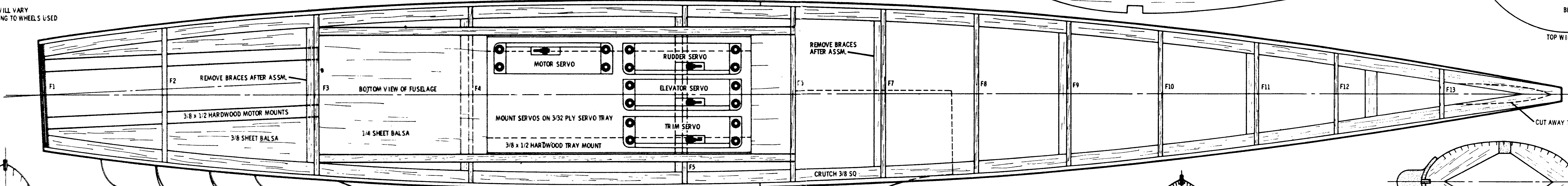
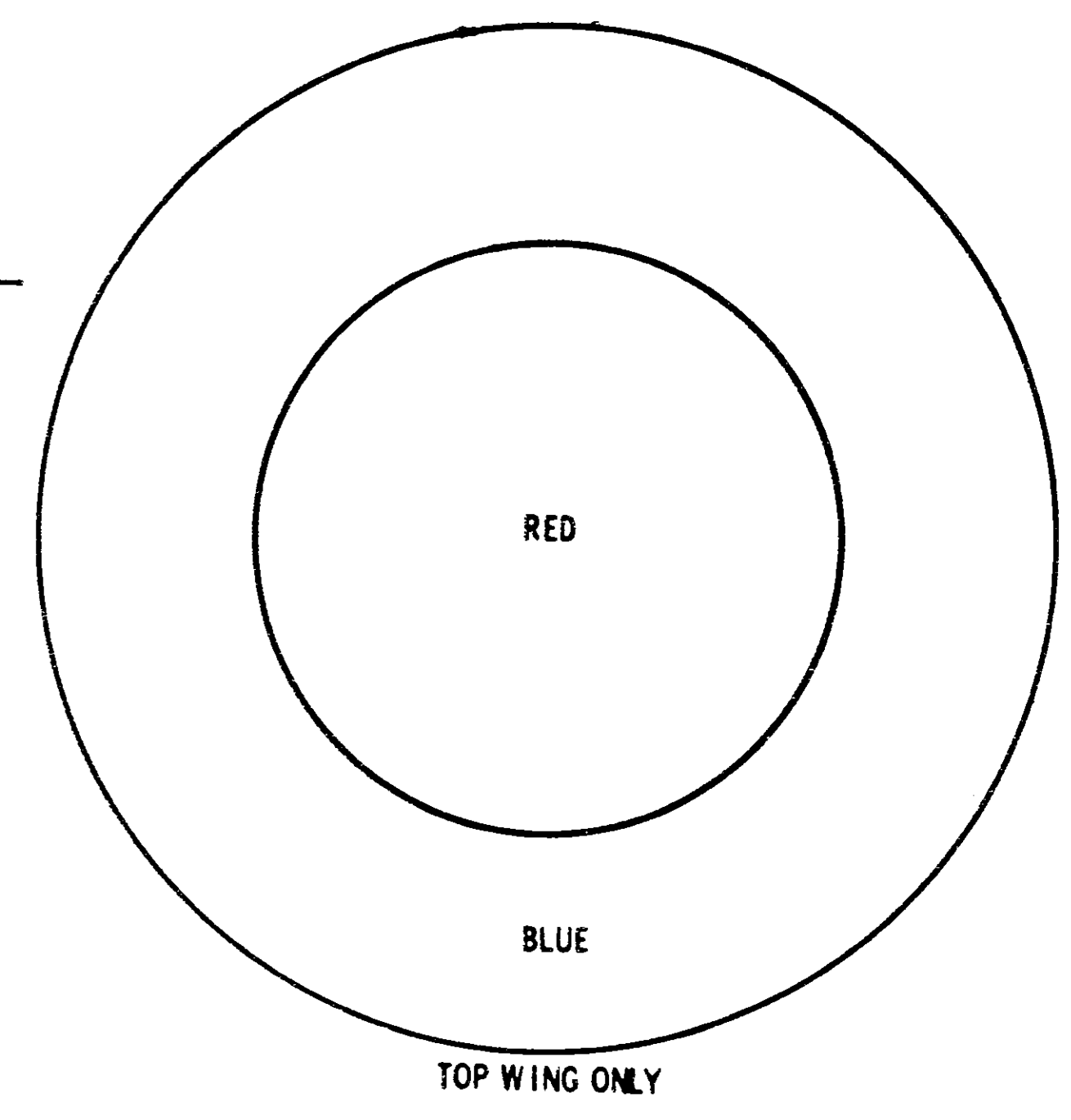
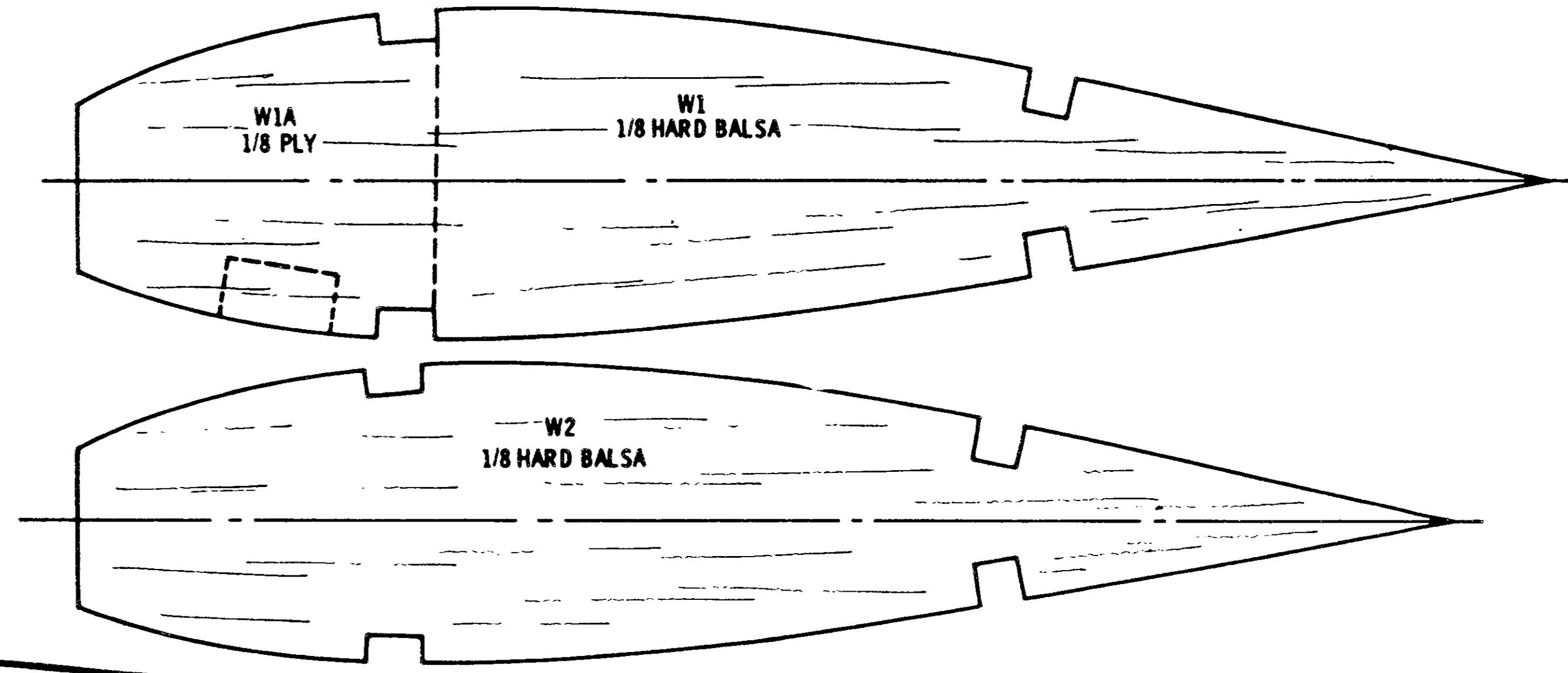
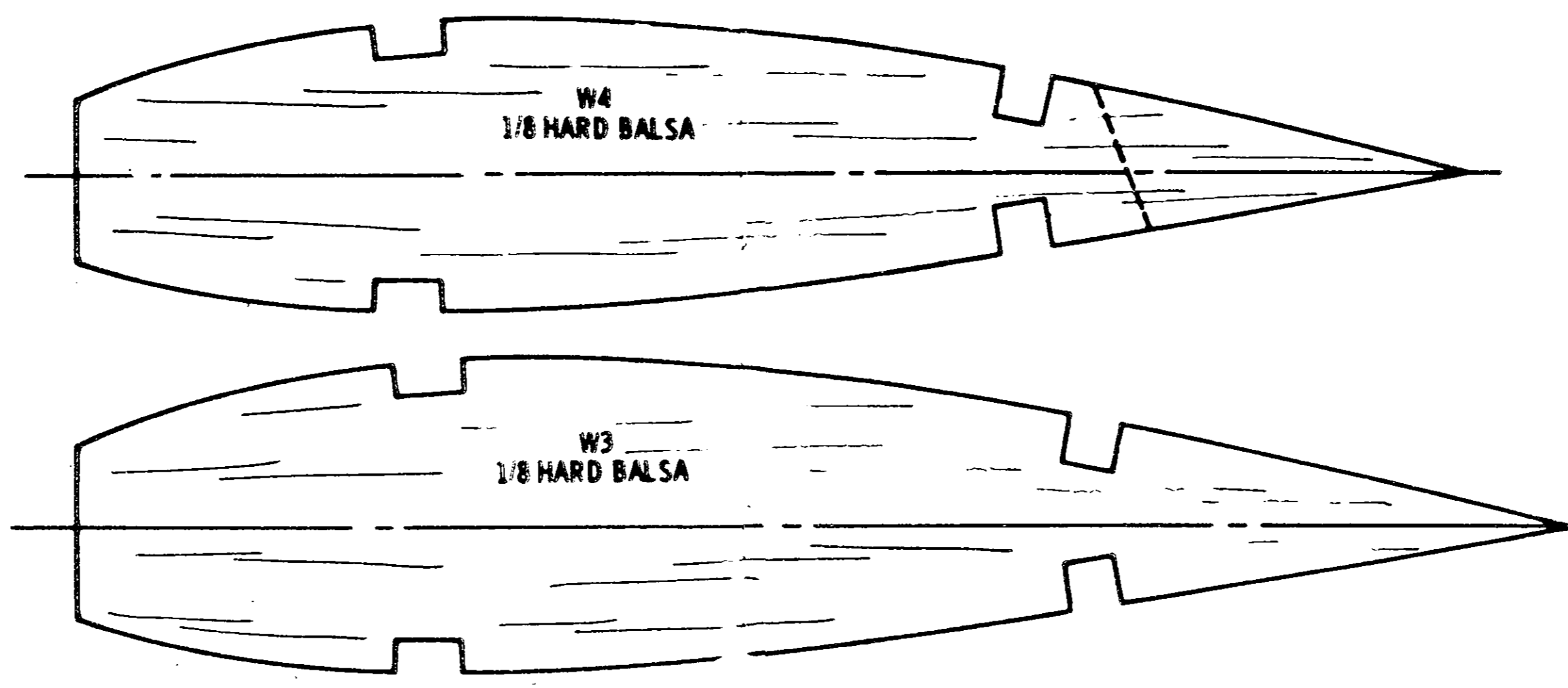
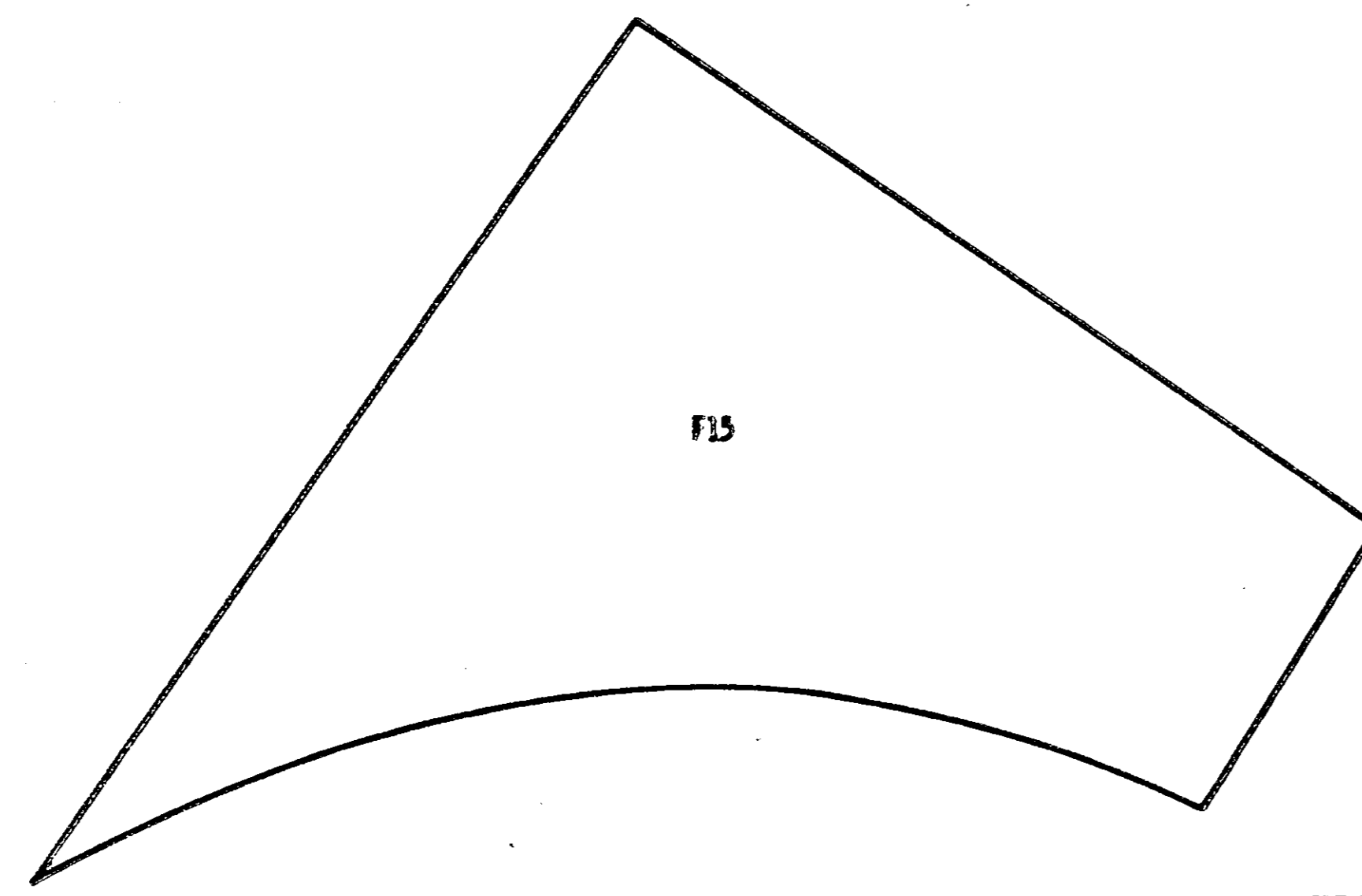